







33 500 671



- 125mm projection
- fixed spout
- rectangular, air-enriched flow
- height of mixer 170 mm
- height up to aerator 71 mm
- hole diameter 35 mm
- 2x screw-in M 10 x 1 pressure hose, leak-tested
- max. flow 4.6 l/min
- lead-free
- This product can help a building meet the requirements of Green Building Rating Systems, e.g. LEED®, BREEAM®, DGNB

Only suitable for basins with an overflow.

	Chrome	33 500 671-00
	Brushed Platinum	33 500 671-06
	Dark Chrome	33 500 671-19
	Brushed Light Gold	33 500 671-27
	Matte Black	33 500 671-33
	Brushed Chrome	33 500 671-93
	Brushed Dark Platinum	33 500 671-99

33 500 671

mm [inches]

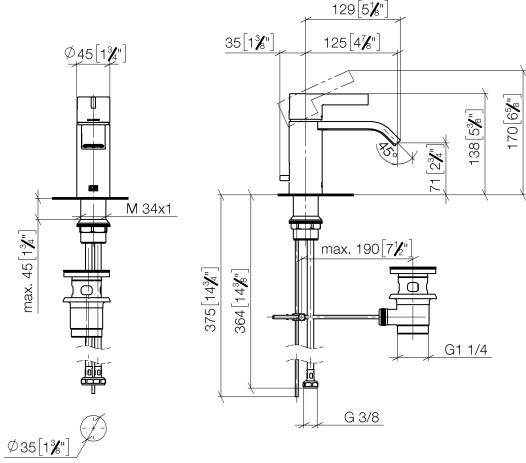

**Flow rate chart**

