

33 500 882



- 137mm projection
- pivotable spout 360°
- circular, air-enriched flow
- height of mixer 295 mm
- height up to aerator 187 mm
- hole diameter 35 mm
- 2x screw-in M 8 x 1 pressure hose, leak-tested
- max. flow 5.7 l/min
- lead-free
- This product can help a building meet the requirements of Green Building Rating Systems, e.g. LEED®, BREEAM®, DGNB

Only suitable for basins with an overflow.

	Brushed Platinum	33 500 882-06
	Chrome	33 500 882-00
	Platinum	33 500 882-08
	Dark Chrome	33 500 882-19
	Brushed Durabronze (23kt Gold)	33 500 882-28
	Matte Black	33 500 882-33
	Brushed Champagne (22kt Gold)	33 500 882-46
	Champagne (22kt Gold)	33 500 882-47
	Brushed Chrome	33 500 882-93
	Brushed Dark Platinum	33 500 882-99

33 500 882

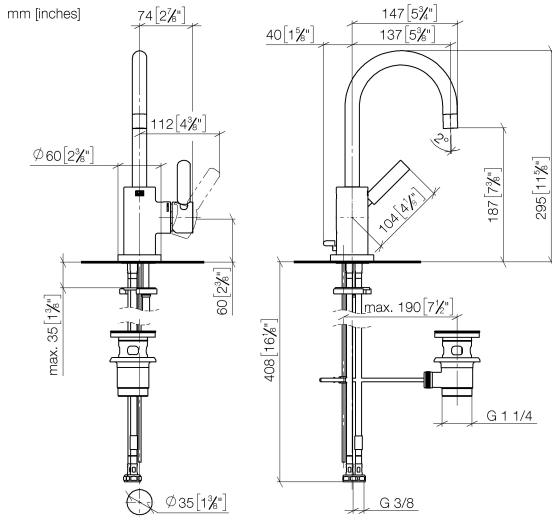

Flow rate chart



Certificates

LGA_38418.

WRAS_2212025.

33 500 882

Parts for other finishes can be found here: [Chrome](#)

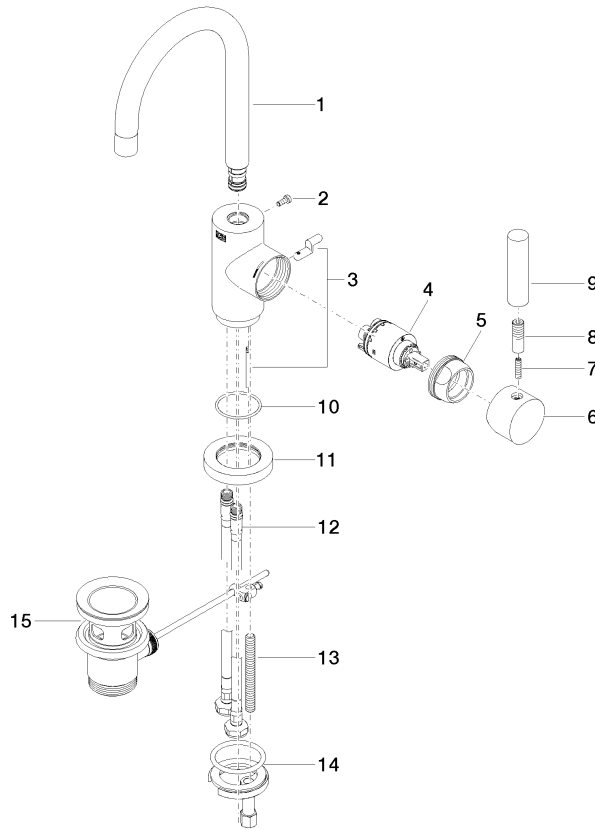

Spare parts list

No.	Item Number	Name	Quantity used	Delivery time
1	90 28 22 371 00-06	spout	1	10
2	09 30 30 054 90	screw	1	2
3	04 20 16 031 80-06	pull-rod	1	60
4	90 15 05 065 00 90	cartridge	1	2
5	09 24 04 107-06	nut	1	10
6	90 20 88 040 00-06	handle	1	10
7	09 31 11 010 90	pin	1	2
8	90 24 04 048 00-06	nipple	1	10
9	11 170 880-06	handle	1	10
10	09 14 10 034 90	seal	1	2
11	09 28 10 055-06	rosette	1	10
12	04 30 04 104 00 90	hose	2	2
13	09 31 11 011 90	pin	1	2
14	04 30 11 038 00 90	fixing set	1	2
15	90 11 01 001 00-06	pop-up waste	1	10