









33 502 660



- 135mm projection
- fixed spout
- circular, air-enriched flow
- height of mixer 158 mm
- height up to aerator 77 mm
- hole diameter 35 mm
- 2x screw-in M 8 x 1 pressure hose, leak-tested
- max. flow 5.7 l/min
- lead-free
- This product can help a building meet the requirements of Green Building Rating Systems, e.g. LEED®, BREEAM®, DGNB

Only suitable for basins with an overflow.

	Champagne (22kt Gold)	33 502 660-47
	Chrome	33 502 660-00
	Brushed Platinum	33 502 660-06
	Dark Chrome	33 502 660-19
	Light Gold	33 502 660-26
	Brushed Light Gold	33 502 660-27
	Matte Black	33 502 660-33
	Brushed Bronze	33 502 660-42
	Brushed Champagne (22kt Gold)	33 502 660-46
	Brushed Chrome	33 502 660-93
	Brushed Dark Platinum	33 502 660-99

33 502 660

mm [inches]

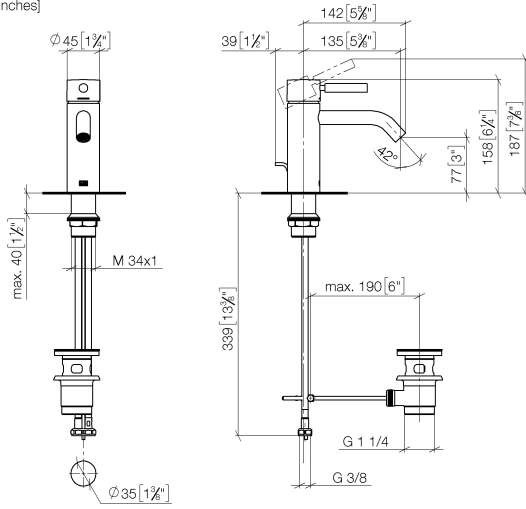

**Flow rate chart**



33 502 660

Parts for other  
finishes can be found  
here: [Chrome](#)

