









33 505 809



- 106mm projection
- fixed spout
- circular, air-enriched flow
- height of mixer 141 mm
- height up to aerator 56 mm
- hole diameter 35 mm
- 2x screw-in M 8 x 1 pressure hose, leak-tested
- max. flow 5.7 l/min
- lead-free
- This product can help a building meet the requirements of Green Building Rating Systems, e.g. LEED®, BREEAM®, DGNB

Only suitable for basins with an overflow.

	Brushed Dark Platinum	33 505 809-99
	Chrome	33 505 809-00
	Brushed Platinum	33 505 809-06
	Platinum	33 505 809-08
	Dark Chrome	33 505 809-19
	Brushed Durabronze (23kt Gold)	33 505 809-28
	Brushed Bronze	33 505 809-42
	Brushed Champagne (22kt Gold)	33 505 809-46
	Champagne (22kt Gold)	33 505 809-47

33 505 809

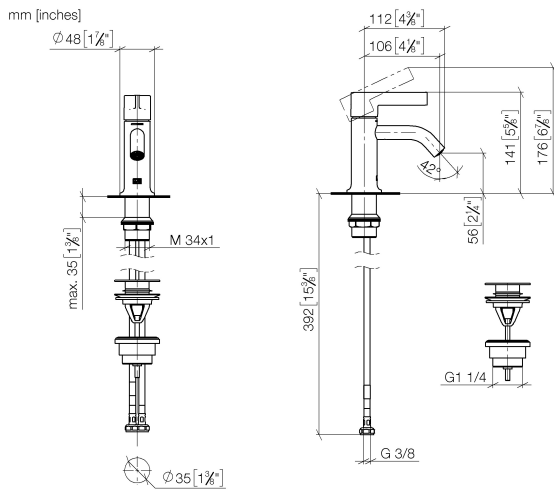

Flow rate chart



Certificates

LGA_38420.

WRAS_240102018.



VAIA Single-lever basin mixer with pop-up waste - Brushed Dark Platinum

VAIA

33 505 809

Spare parts list

No.	Item Number	Name	Quantity used	Delivery time
1	90 31 20 087 00-99	plug	1	30
2	90 31 11 063 00 90	pin	1	2
3	09 20 80 020-99	handle	1	30
4	09 28 30 021-99	cover	1	30
5	09 24 04 266 90	nut	1	2
6	90 15 05 042 00 90	cartridge	1	2
7	90 11 06 215 00-99	spout	1	30
8	04 23 10 044 07 90	fixing set	1	2
9	04 30 04 100 00 90	hose	2	2
10	10 125 970-99	Basin Waste with push fastening 1 1/4" - Brushed Dark Platinum	1	2