







33 521 845 Product version from 3/9/2016 to 10/31/2018



- 130mm projection
- fixed spout
- circular, air-enriched flow
- height of mixer 127 mm
- height up to aerator 75 mm
- hole diameter 35 mm
- 2x screw-in M 8 x 1 pressure hose, leak-tested
- max. flow 5.7 l/min
- lead-free
- This product can help a building meet the requirements of Green Building Rating Systems, e.g. LEED®, BREEAM®, DGNB
- WRAS

	Matte Black	33 521 845-33
	Chrome	33 521 845-00
	Brushed Platinum	33 521 845-06
	Dark Chrome	33 521 845-19
	Brushed Light Gold	33 521 845-27
	Brushed Chrome	33 521 845-93
	Brushed Dark Platinum	33 521 845-99

33 521 845 Product version from 3/9/2016 to 10/31/2018

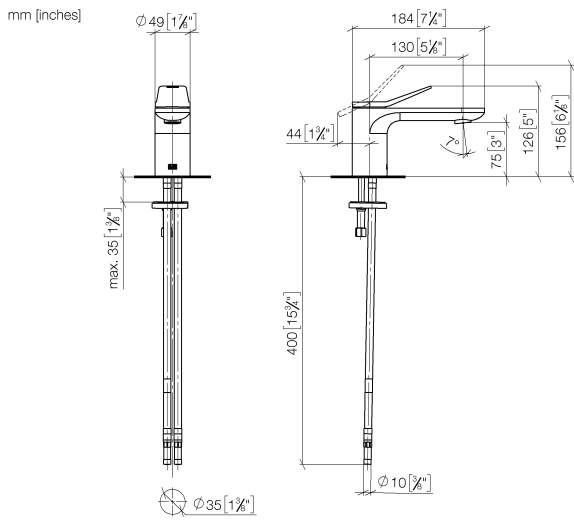

Flow rate chart



Codes & Standards

DIN 4109

Executive Order
no. 1007

ISO 3822

Ü-Zeichen



LISSÉ Single-lever basin mixer without pop-up waste - Matte Black

LISSÉ

33 521 845 Product version from 3/9/2016 to 10/31/2018

Certificates and sustainability

LGA_29

GDV_0400

33 521 845 Product version from 3/9/2016 to 10/31/2018

Parts for other finishes can be found here: [Chrome](#)

