

















META Single-lever basin mixer without pop-up waste - Brushed Durabronze (23kt Gold)

META

33 525 660



- 105mm projection
- fixed spout
- circular, air-enriched flow
- height of mixer 138 mm
- height up to aerator 57 mm
- hole diameter 35 mm
- rosette Ø 50 mm optional
- 2x screw-in M 8 x 1 pressure hose, leak-tested
- max. flow 5.7 l/min
- lead-free
- This product can help a building meet the requirements of Green Building Rating Systems, e.g. LEED®, BREEAM®, DGNB

	Brushed Durabronze (23kt Gold)	33 525 660-28
	Chrome	33 525 660-00
	Brushed Platinum	33 525 660-06
	Platinum	33 525 660-08
	Dark Chrome	33 525 660-19
	Light Gold	33 525 660-26
	Brushed Light Gold	33 525 660-27
	Red	33 525 660-29
	Orange	33 525 660-30
	Dark Green	33 525 660-31
	Matte Black	33 525 660-33
	Brushed Bronze	33 525 660-42
	Brushed Champagne (22kt Gold)	33 525 660-46
	Champagne (22kt Gold)	33 525 660-47
	Brushed Chrome	33 525 660-93
	Brushed Dark Platinum	33 525 660-99

33 525 660
mm [inches]

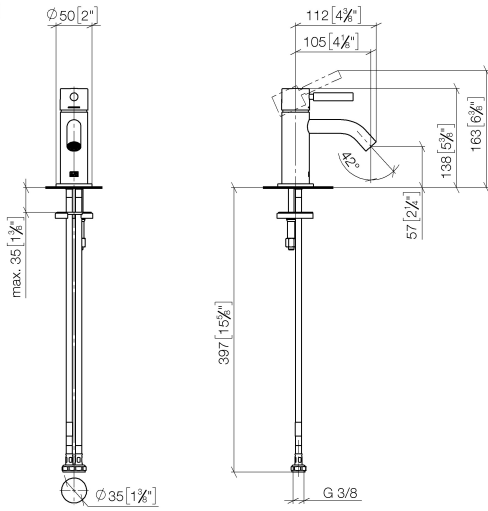

Flow rate chart



Certificates

LGA_29690.

DVGW_DW-
6506DN0128.

WRAS_2003058.

33 525 660
Parts for other
finishes can be found
here: [Chrome](#)

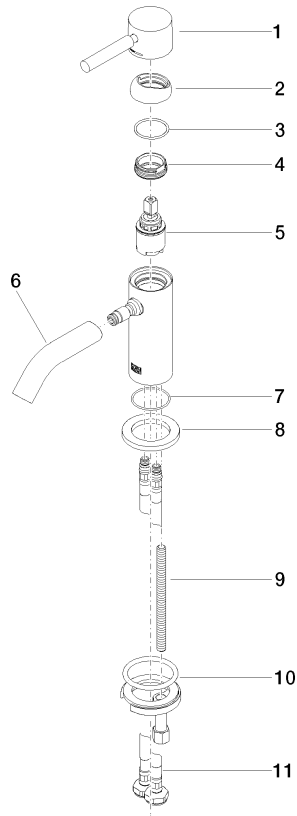

Spare parts list

No.	Item Number	Name	Quantity used	Delivery time
1	90 20 66 009 00-28	handle	1	20
2	09 28 30 043-28	cover	1	20
3	09 14 10 120 90	seal	1	2
4	09 24 04 266 90	nut	1	2
5	90 15 05 044 00 90	cartridge	1	2
6	90 11 06 212 00-28	spout	1	20
7	09 14 10 202 90	seal	1	2
8	09 27 66 006-28	rosette	1	20
9	09 31 11 012 90	pin	1	2
10	04 30 11 038 00 90	fixing set	1	2
11	04 30 04 100 00 90	hose	2	2