

















33 525 660



- 105mm projection
- fixed spout
- circular, air-enriched flow
- height of mixer 138 mm
- height up to aerator 57 mm
- hole diameter 35 mm
- rosette Ø 50 mm optional
- 2x screw-in M 8 x 1 pressure hose, leak-tested
- max. flow 5.7 l/min
- lead-free
- This product can help a building meet the requirements of Green Building Rating Systems, e.g. LEED®, BREEAM®, DGNB

| | | |
|---|-------------------------------------|---------------|
|  | Matte Black | 33 525 660-33 |
|  | Chrome | 33 525 660-00 |
|  | Brushed Platinum | 33 525 660-06 |
|  | Platinum | 33 525 660-08 |
|  | Dark Chrome | 33 525 660-19 |
|  | Light Gold | 33 525 660-26 |
|  | Brushed Light Gold | 33 525 660-27 |
|  | Brushed Durabronze (23kt Gold) | 33 525 660-28 |
|  | Red | 33 525 660-29 |
|  | Orange | 33 525 660-30 |
|  | Dark Green | 33 525 660-31 |
|  | Brushed Bronze | 33 525 660-42 |
|  | Brushed Champagne (22kt Gold) | 33 525 660-46 |
|  | Champagne (22kt Gold) | 33 525 660-47 |
|  | Brushed Chrome | 33 525 660-93 |
|  | Brushed Dark Platinum | 33 525 660-99 |

33 525 660

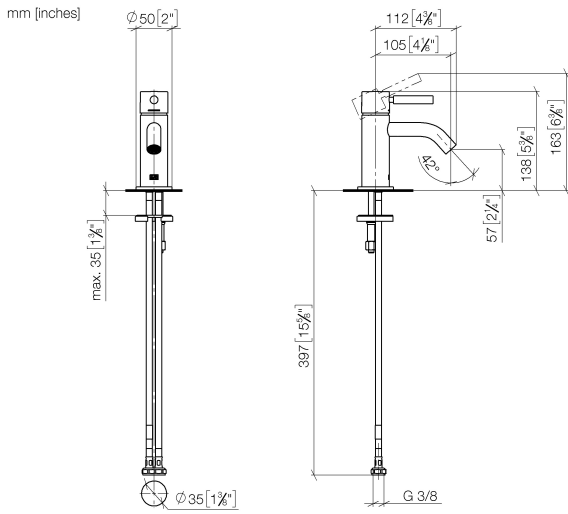

Flow rate chart



Certificates

LGA_29690.

DVGW_DW-
6506DN0128.

WRAS_2003058.

33 525 660

Parts for other finishes can be found here: [Chrome](#)

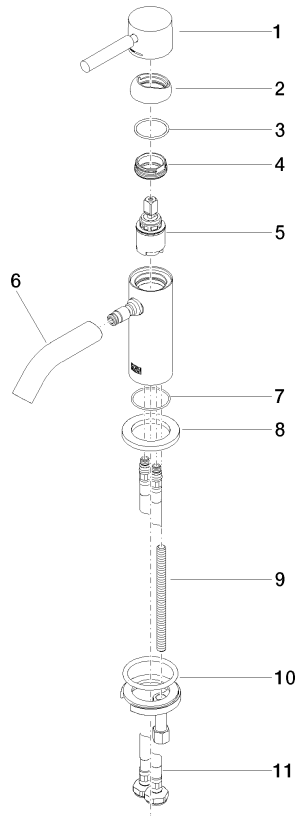

Spare parts list

| No. | Item Number | Name | Quantity used | Delivery time |
|-----|--------------------|------------|---------------|---------------|
| 1 | 90 20 66 009 00-33 | handle | 1 | 30 |
| 2 | 09 28 30 043-33 | cover | 1 | 30 |
| 3 | 09 14 10 120 90 | seal | 1 | 2 |
| 4 | 09 24 04 266 90 | nut | 1 | 2 |
| 5 | 90 15 05 044 00 90 | cartridge | 1 | 2 |
| 6 | 90 11 06 212 00-33 | spout | 1 | 30 |
| 7 | 09 14 10 202 90 | seal | 1 | 2 |
| 8 | 09 27 66 006-33 | rosette | 1 | 30 |
| 9 | 09 31 11 012 90 | pin | 1 | 2 |
| 10 | 04 30 11 038 00 90 | fixing set | 1 | 2 |
| 11 | 04 30 04 100 00 90 | hose | 2 | 2 |