











33 526 660



- 125mm projection
- fixed spout
- circular, air-enriched flow
- height of mixer 133 mm
- height up to aerator 52 mm
- hole diameter 35 mm
- 2x screw-in M 8 x 1 pressure hose, leak-tested
- max. flow 5.7 l/min
- lead-free
- This product can help a building meet the requirements of Green Building Rating Systems, e.g. LEED®, BREEAM®, DGNB
- WRAS 2003058

	Brushed Chrome	33 526 660-93
	Chrome	33 526 660-00
	Brushed Platinum	33 526 660-06
	Dark Chrome	33 526 660-19
	Light Gold	33 526 660-26
	Brushed Light Gold	33 526 660-27
	Matte Black	33 526 660-33
	Brushed Bronze	33 526 660-42
	Brushed Champagne (22kt Gold)	33 526 660-46
	Champagne (22kt Gold)	33 526 660-47
	Brushed Dark Platinum	33 526 660-99

33 526 660

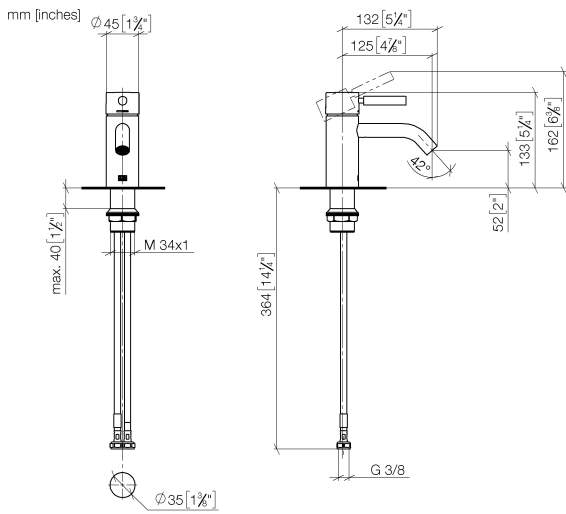

Flow rate chart



Certificates

LGA_29690.

WRAS_2003058.

33 526 660

Parts for other finishes can be found here: [Chrome](#)

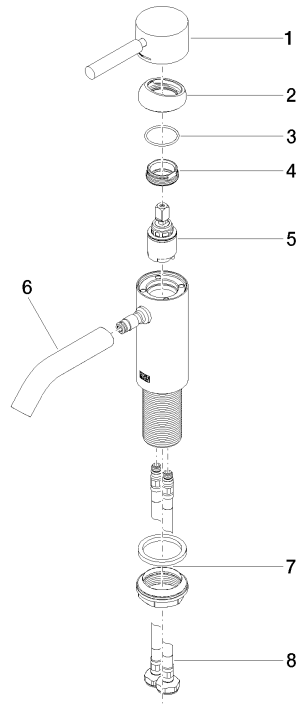

Spare parts list

No.	Item Number	Name	Quantity used	Delivery time
1	90 20 66 002 00-93	handle	1	20
2	09 28 30 041-93	cover	1	20
3	09 14 10 091 90	seal	1	2
4	09 24 04 266 90	nut	1	2
5	90 15 05 044 00 90	cartridge	1	2
6	90 11 06 206 00-93	spout	1	20
7	04 23 10 044 07 90	fixing set	1	2
8	04 30 04 100 00 90	hose	2	2