

**MEM Single-lever mixer - Platinum**

MEM

33 815 682



- 241mm projection
- pivotable spout 360°
- Optional swivel limiter available with swivel limiter set 12 820 970 90
- air-enriched flow
- max. flow 6.3 l/min at 3 bar flow pressure
- lead-free
- This product can help a building meet the requirements of Green Building Rating Systems, e.g. LEED®, BREEAM®, DGNB
- WRAS 240202021

	Platinum	33 815 682-08
	Chrome	33 815 682-00
	Brushed Platinum	33 815 682-06
	Durabronze (23kt Gold)	33 815 682-09
	Dark Chrome	33 815 682-19
	Brushed Durabronze (23kt Gold)	33 815 682-28
	Matte Black	33 815 682-33
	Brushed Champagne (22kt Gold)	33 815 682-46
	Champagne (22kt Gold)	33 815 682-47
	Brushed Chrome	33 815 682-93
	Brushed Dark Platinum	33 815 682-99

**Recommended miscellaneous**

	<b>Swivel limitation set -</b>	12 820 970 90
---	--------------------------------	---------------

**Recommended miscellaneous**

	<b>Strainer waste with control handle - Platinum</b>	10 712 970-08
---	--	---------------

**Recommended miscellaneous**

	<b>Dispenser without rosette - Platinum</b>	82 424 970-08
---	---	---------------

33 815 682

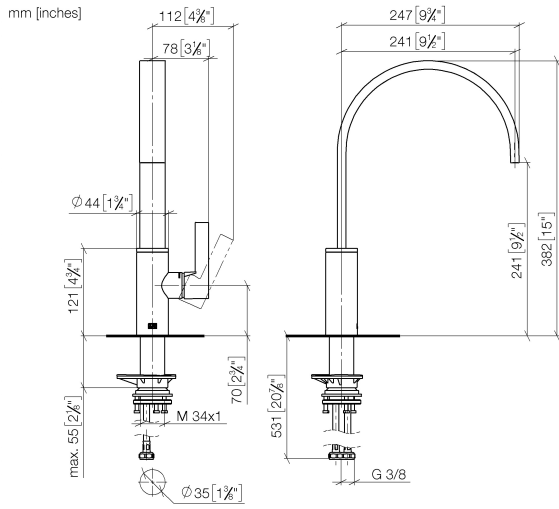

**Flow rate chart**



**Codes & Standards**

DIN 4109

ISO 3822

Scottish Water  
Byelaws

UK Water Supply  
Regulations

**Ü-Zeichen**



## MEM Single-lever mixer - Platinum

---

MEM

33 815 682

### Certificates

---

WRAS\_240202

LGA\_38

33 815 682

Product version from 3/1/2023

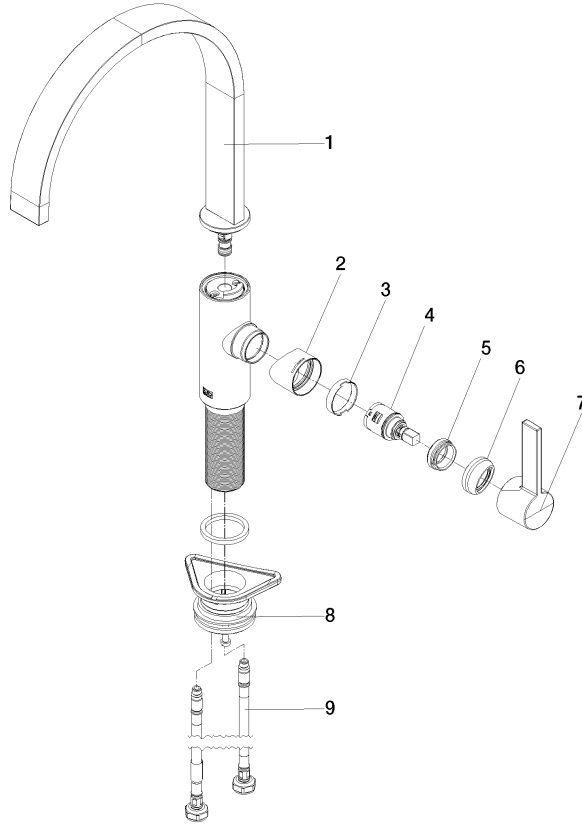



# MEM Single-lever mixer - Platinum

MEM

33 815 682

## Spare parts list

### Product version from 3/1/2023

No.	Item Number	Name	Quantity used	Delivery time
	90 28 22 333 00-08	spout	10	-

Spare part can no longer be ordered, please order the replacement item