











33 815 861



- 235mm projection
- pivotable spout 360°
- Optional swivel limiter available with swivel limiter set 12 820 970 90
- air-enriched flow
- max. flow 8 l/min at 3 bar flow pressure
- lead-free
- This product can help a building meet the requirements of Green Building Rating Systems, e.g. LEED®, BREEAM®, DGNB
- WRAS 240102021

	Durabronss (23kt Gold)	33 815 861-09
	Chrome	33 815 861-00
	Brushed Platinum	33 815 861-06
	Platinum	33 815 861-08
	Dark Chrome	33 815 861-19
	Brushed Durabronss (23kt Gold)	33 815 861-28
	Matte Black	33 815 861-33
	Brushed Champagne (22kt Gold)	33 815 861-46
	Champagne (22kt Gold)	33 815 861-47
	Brushed Chrome	33 815 861-93
	Brushed Dark Platinum	33 815 861-99

Recommended miscellaneous

Swivel limitation set - 12 820 970 90



Recommended miscellaneous

Dispenser without rosette - Durabronss (23kt Gold) 82 424 970-09



Recommended miscellaneous

Strainer waste with control handle - Durabronss (23kt Gold) 10 712 970-09



33 815 861

mm [inches]

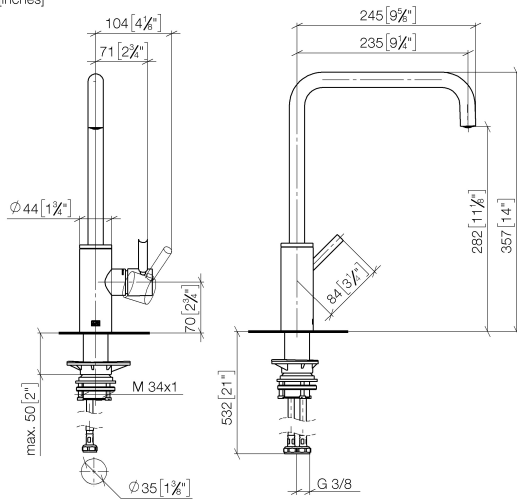

Flow rate chart



Certificates

LGA_38642.

WRAS_240102021.

33 815 861



Spare parts list

No.	Item Number	Name	Quantity used	Delivery time
1	90 28 22 284 00-09	spout	1	40
2	90 15 05 042 00 90	cartridge	1	2
3	09 24 04 266 90	nut	1	2
4	90 28 30 052 00-09	cover	1	40
5	90 20 66 033 00-09	handle	1	40
6	04 23 10 044 08 90	fixing set	1	2
7	04 30 04 101 00 90	hose	2	2