

TARA Single-lever mixer for rinsing/Profi spray - Brushed Dark Platinum

33 826 888



- 235mm projection
- pivotable spout 360°
- air-enriched flow
- height of mixer 400 mm
- height up to aerator 230 mm
- single-lever mixer hole diameter 35mm
- max. flow 7 l/min at 3 bar flow pressure
- lead-free
- WRAS 2311044
- This product can help a building meet the requirements of Green Building Rating Systems, e.g. LEED®, BREEAM®, DGNB

Single-lever mixer for combining with rinsing/Profi spray only

	Brushed Dark Platinum	33 826 888-99
	Chrome	33 826 888-00
	Brushed Platinum	33 826 888-06
	Platinum	33 826 888-08
	Durabronze (23kt Gold)	33 826 888-09
	Dark Chrome	33 826 888-19
	Brushed Durabronze (23kt Gold)	33 826 888-28
	Matte Black	33 826 888-33
	Brushed Champagne (22kt Gold)	33 826 888-46
	Champagne (22kt Gold)	33 826 888-47
	Brushed Chrome	33 826 888-93

Recommended miscellaneous



Rinsing spray set - Brushed Dark Platinum 27 721 970-99

Recommended miscellaneous



Profi spray set - Brushed Dark Platinum 27 789 970-99

TARA Single-lever mixer for rinsing/Profi spray - Brushed Dark Platinum

33 826 888

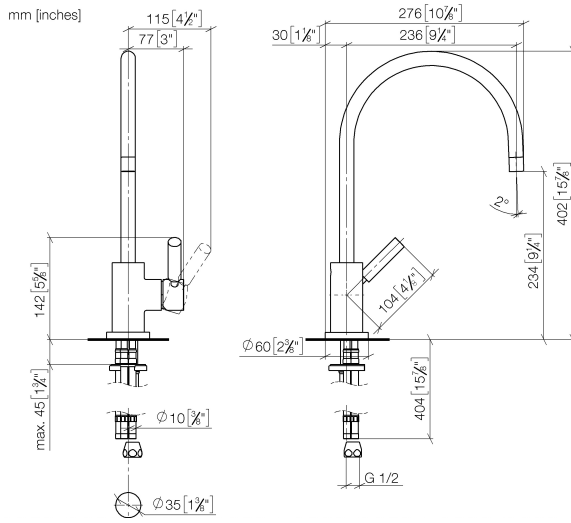

Flow rate chart



Certificates

LGA_18901.

ETA_18524.

WRAS_2311044.

TARA Single-lever mixer for rinsing/Profi spray - Brushed Dark Platinum

33 826 888

Parts for other finishes can be found here: [Chrome](#)

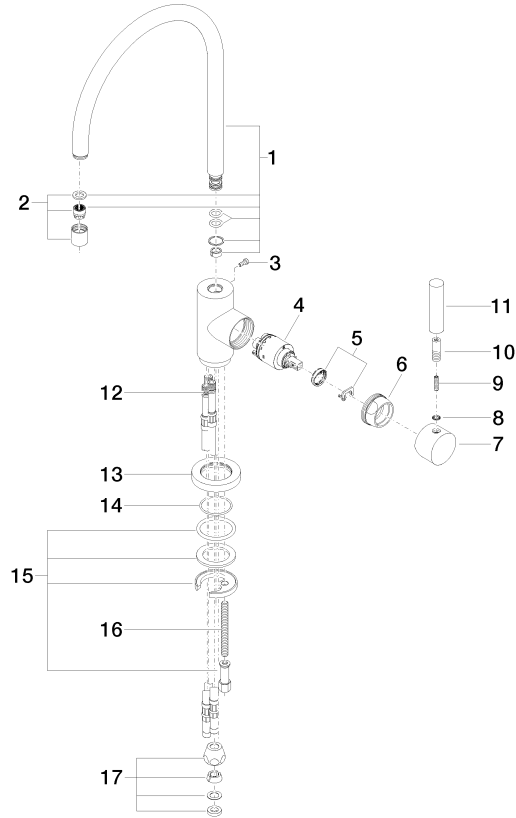

Spare parts list

No.	Item Number	Name	Quantity used	Delivery time
1	90 28 22 049 02-99	spout	1	30
2	90 23 01 028 03-99	aerator	1	30
3	09 30 30 054 90	screw	1	2
4	90 15 05 065 00 90	cartridge	1	2
5	90 28 10 148 00 90	accessories	1	2
6	09 24 04 107-99	nut	1	30
7	90 20 88 040 00-99	handle	1	30
8	90 30 11 032 00 90	disc	1	2
9	09 31 11 010 90	pin	1	2
10	90 24 04 048 00-99	nipple	1	30
11	11 170 880-99	handle	1	30
12	04 30 04 064 00 90	hose	3	60
13	09 28 10 055-99	rosette	1	30
14	09 14 10 034 90	seal	1	2
15	04 30 11 038 00 90	fixing set	1	2
16	09 31 11 011 90	pin	1	2
17	90 23 30 040 00-99	threaded connector	1	30