







33 880 888 Product version from 5/3/2021



- 200mm projection
- pivotable spout 360°
- air-enriched flow and spray flow
- height of mixer 415 mm
- test
- height up to aerator 275 mm
- hole diameter 35 mm
- sprayface with anti-scaling system
- max. flow 7 l/min at 3 bar flow pressure
- lead-free
- This product can help a building meet the requirements of Green Building Rating Systems, e.g. LEED®, BREEAM®, DGNB

Intrinsic protection against back flow.

	Chrome	33 880 888-00
	Brushed Platinum	33 880 888-06
	Platinum	33 880 888-08
	Dark Chrome	33 880 888-19
	Brushed Chrome	33 880 888-93
	Brushed Dark Platinum	33 880 888-99

Recommended miscellaneous

Strainer waste with control handle - Chrome 10 710 970-00



Recommended miscellaneous

Dispenser with rosette - Chrome 82 444 970-00



33 880 888 Product version from 5/3/2021

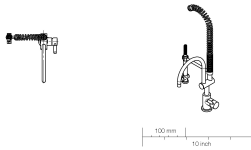
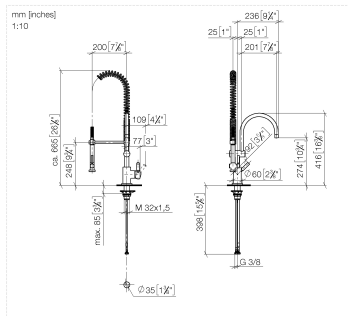

Flow rate chart



Codes & Standards

EN 1717



TARA Profi single-lever mixer - Chrome

TARA

33 880 888 Product version from 5/3/2021

Certificates

Belgaqua_21-027-2

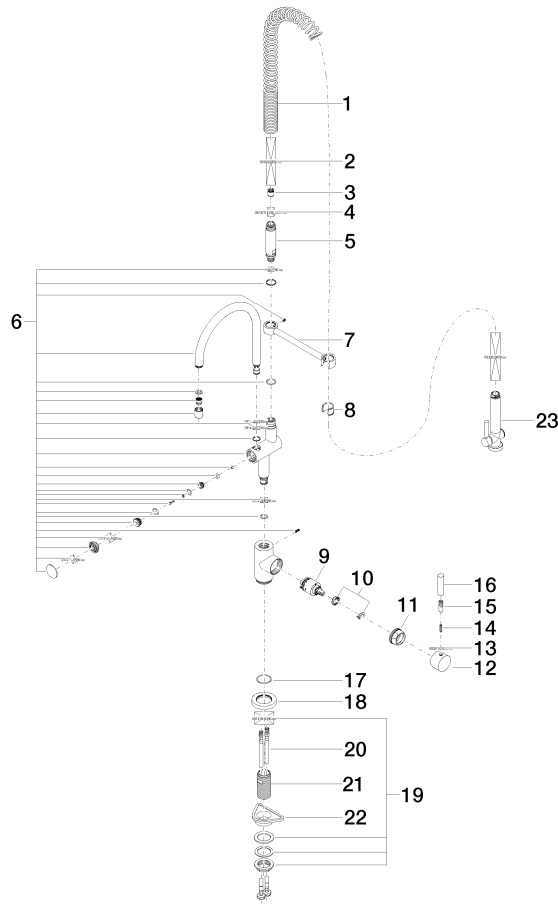

Spare parts list

No.	Item Number	Name	Quantity used	Delivery time
1	09 16 02 034 90	spring	1	2
2	90 30 02 065 00-00	hose	1	10
3	09 23 01 046 90	back-flow preventer	1	2
4	90 23 01 141 00 90	back-flow preventer	1	2
5	09 30 01 067 10-00	adaptor	1	10
6	90 19 88 019 00-00	spout	1	10
7	04 17 20 014 00-00	holder	1	10
8	90 18 40 035 00 90	sleeve	1	2
9	90 15 05 065 00 90	cartridge	1	2
10	90 28 10 148 00 90	accessories	1	2
11	09 24 04 107-00	nut	1	10
12	90 20 88 040 00-00	handle	1	10
13	90 30 11 032 00 90	disc	1	2
14	09 31 11 010 90	pin	1	2
15	90 24 04 048 00-00	nipple	1	10
16	09 20 62 005-00	handle	1	10
17	09 14 10 102 90	seal	1	2
18	09 28 10 055-00	rosette	1	10
19	04 23 10 009 02 90	fixing set	1	2
20	04 30 04 105 00 90	hose	2	2
21	09 30 01 010 90	adaptor	1	2
22	09 18 40 090 90	sleeve	1	2
23	90 12 11 097 11-00	shower	1	10