





EDITION PRO Shower thermostat for wall mounting - Matte Black

34 442 626



- slide-on rosettes Ø 70 mm
- gauge 150 mm - 13 mm
- rotary diverter with volume control and shut-off function
- 3/8" shower outlet
- with volume control
- WRAS 2204005

Intrinsic protection against back flow.

	Matte Black	34 442 626-33
	Chrome	34 442 626-00
	Brushed Chrome	34 442 626-93

EDITION PRO Shower thermostat for wall mounting - Matte Black

34 442 626

mm [inches]

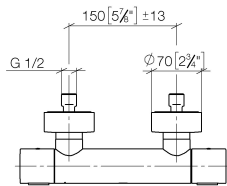
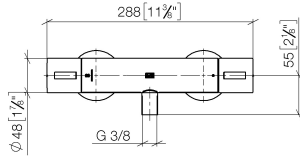

Flow rate chart

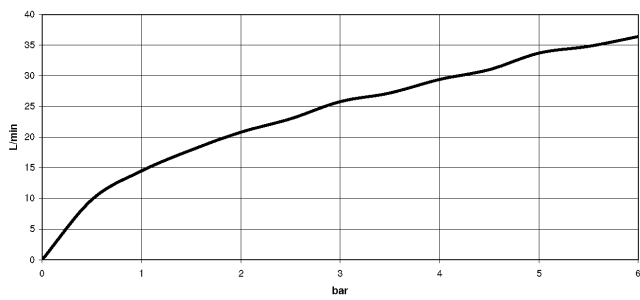

Certificates

Belgaqua_21-384- 27_5. LGA_29986. WRAS_2204005.

EDITION PRO Shower thermostat for wall mounting - Matte Black

34 442 626

Parts for other finishes can be found here: [Chrome](#)

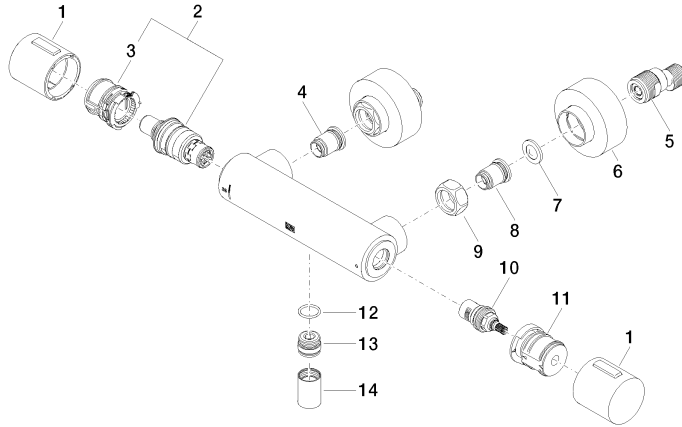

Spare parts list

No.	Item Number	Name	Quantity used	Delivery time
1	90 17 33 015 00-33	handle	2	30
2	90 15 02 070 00 90	cartridge	1	2
3	90 30 40 010 00 90	regulator	1	2
4	04 31 20 530 00 90	insert	1	2
5	04 11 04 030 00 90	connection	2	2
6	90 31 20 512 00-33	rosette	2	30
7	09 29 30 050 90	sieve	2	2
8	04 31 20 540 00 90	insert	1	2
9	09 24 77 008-00	nut	2	10
10	90 90 03 236 00 90	top	1	2
11	90 30 40 017 00 90	base	1	2
12	90 14 10 010 00 90	seal	1	2
13	09 31 20 511-33	nipple	1	60
14	90 21 02 069 00-33	cover	1	30