

**TARA Shower pipe with shower thermostat without hand shower FlowReduce  
220 mm - Brushed Dark Platinum**

TARA

34 458 892



- shower with fixed riser projection 452mm
- Rain shower: PURE RAIN, max. flow rate 7 l/min (at 3 bar)
- Function from: 6 l/min
- rain shower Ø 220 mm
- rain shower with anti-scale system
- rotary diverter with volume control and shut-off function
- slide-on rosettes Ø 70 mm
- height of fittings up to rain shower (bottom edge) 964mm
- height of fittings up to top edge of elbow 1267mm
- gauge 150 mm - 13 mm
- metal shower hose 1750mm with integrated anti-twist protection
- 1/2" connection
- slide bar
- Pipe diameter 23.5 mm
- This product can help a building meet the requirements of Green Building Rating Systems, e.g. LEED®, BREEAM®, DGNB
- WRAS 2204013

This article does not include a hand shower!

Intrinsic protection against back flow.

	Brushed Dark Platinum	34 458 892-99
	Chrome	34 458 892-00
	Brushed Platinum	34 458 892-06
	Platinum	34 458 892-08
	Dark Chrome	34 458 892-19
	Brushed Durabronze (23kt Gold)	34 458 892-28
	Matte Black	34 458 892-33
	Brushed Bronze	34 458 892-42
	Brushed Champagne (22kt Gold)	34 458 892-46
	Champagne (22kt Gold)	34 458 892-47
	Brushed Chrome	34 458 892-93

**TARA Shower pipe with shower thermostat without hand shower FlowReduce  
220 mm - Brushed Dark Platinum**

TARA

34 458 892

Required miscellaneous

	<b>Hand shower FlowReduce - Brushed Dark Platinum</b>	28 012 979-99 0010
---	---	-----------------------

Required miscellaneous

	<b>Hand shower - Brushed Dark Platinum</b>	28 016 979-99
---	--	---------------

Required miscellaneous

	<b>Hand shower - Brushed Dark Platinum</b>	28 012 979-99
---	--	---------------

Required miscellaneous

	<b>Hand shower FlowReduce - Brushed Dark Platinum</b>	28 016 979-99 0010
---	---	-----------------------

Required miscellaneous

	<b>Hand shower FlowReduce - Brushed Dark Platinum</b>	28 018 979-99 0010
---	---	-----------------------

Required miscellaneous

	<b>SERIES-VARIOUS Hand shower - Brushed Dark Platinum</b>	28 029 979-99
---	---	---------------

Required miscellaneous

	<b>SERIES-VARIOUS Hand shower - Brushed Dark Platinum</b>	28 029 979-99 0010
---	---	-----------------------

Required miscellaneous

	<b>SERIES-VARIOUS Hand shower - Brushed Dark Platinum</b>	28 025 979-99 0010
---	---	-----------------------

Required miscellaneous

	<b>Hand shower - Brushed Dark Platinum</b>	28 017 979-99
---	--	---------------

Required miscellaneous

	<b>Hand shower - Brushed Dark Platinum</b>	28 016 979-99
---	--	---------------

Required miscellaneous

	<b>Hand shower FlowReduce - Brushed Dark Platinum</b>	28 016 979-99 0010
---	---	-----------------------

Required miscellaneous

	<b>Hand shower - Brushed Dark Platinum</b>	28 018 979-99
---	--	---------------

Required miscellaneous

	<b>SERIES-VARIOUS Hand shower - Brushed Dark Platinum</b>	28 029 979-99
---	---	---------------

Required miscellaneous

	<b>SERIES-VARIOUS Hand shower - Brushed Dark Platinum</b>	28 029 979-99 0010
---	---	-----------------------

Required miscellaneous

	<b>SERIES-VARIOUS Hand shower - Brushed Dark Platinum</b>	28 027 979-99 0010
---	---	-----------------------

**TARA Shower pipe with shower thermostat without hand shower FlowReduce  
220 mm - Brushed Dark Platinum**

TARA

34 458 892  
mm [inches]  
1:10

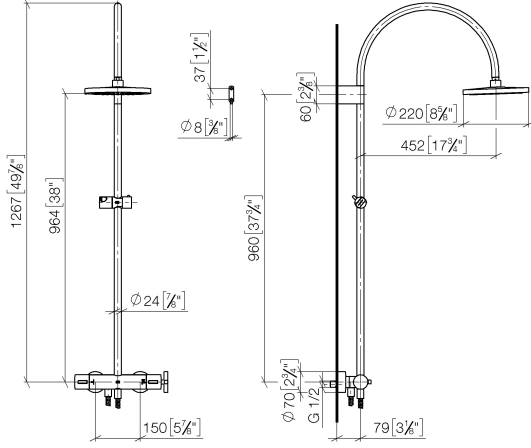

**Flow rate chart**

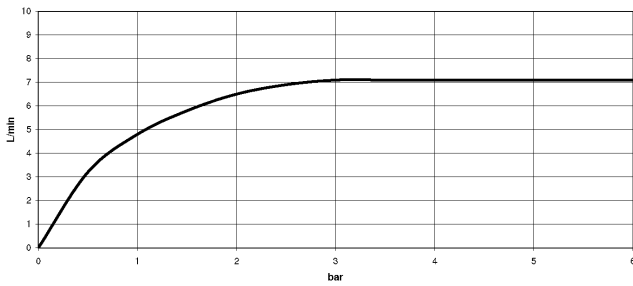

**Codes & Standards**

DIN 4109	EN 1717	ISO 3822	Scottish Water Byelaws
UK Water Supply Regulations	Ü-Zeichen		



TARA Shower pipe with shower thermostat without hand shower FlowReduce  
220 mm - Brushed Dark Platinum

---

TARA

34 458 892

Certificates

---

WRAS\_2204

LGA\_38

Belgaqua\_22\_283\_2

34 458 892

**Product version from 5/1/2022**

Parts for other  
finishes can be found  
here: [Chrome](#)

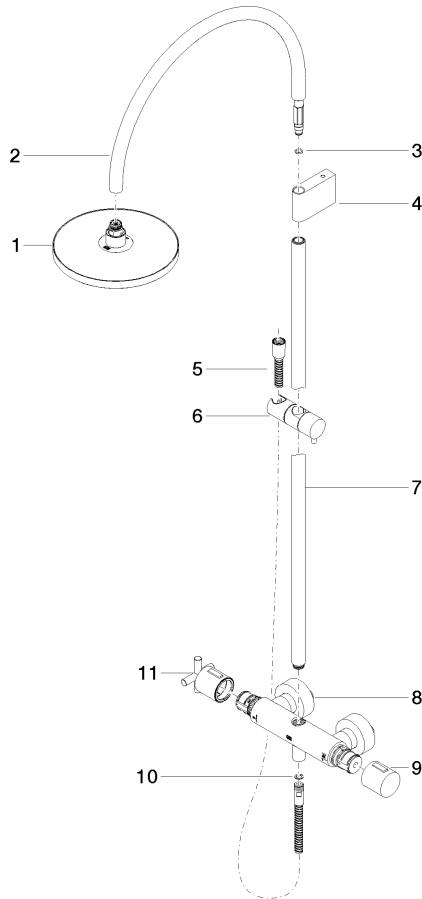



TARA Shower pipe with shower thermostat without hand shower FlowReduce  
220 mm - Brushed Dark Platinum

TARA

34 458 892

### Spare parts list

#### Product version from 5/1/2022

No.	Item Number	Name	Quantity used	Delivery time
	90 12 05 092 20-99	shower	11	30