

**Showerpipe with shower thermostat without hand shower FlowReduce 220 mm  
- Brushed Platinum**

TARA

34 459 892















Fits: TARA, VAIA, META

- shower with fixed riser projection 452mm
- overhead shower: rain flow
- rain shower Ø 220 mm
- rain shower with anti-scale system
- max. rainshower flow 7 l/min
- rotary diverter with volume control and shut-off function
- slide-on rosettes Ø 70 mm
- height of fittings up to rain shower (bottom edge) 963mm
- height of fittings up to top edge of elbow 1267mm
- gauge 150 mm - 13 mm
- metal shower hose 1750mm with integrated anti-twist protection
- 1/2" connection
- slide bar
- Pipe diameter 23.5 mm
- quick clearing
- This product can help a building meet the requirements of Green Building Rating Systems, e.g. LEED®, BREEAM®, DGNB
- WRAS 2204013

This article does not include a hand shower!

Intrinsic protection against back flow.

	Brushed Platinum	34 459 892-06
	Chrome	34 459 892-00
	Platinum	34 459 892-08
	Dark Chrome	34 459 892-19
	Brushed Light Gold	34 459 892-27
	Brushed Durabronze (23kt Gold)	34 459 892-28
	Matte Black	34 459 892-33
	Brushed Bronze	34 459 892-42
	Brushed Champagne (22kt Gold)	34 459 892-46
	Champagne (22kt Gold)	34 459 892-47
	Brushed Chrome	34 459 892-93
	Brushed Dark Platinum	34 459 892-99

**Showerpipe with shower thermostat without hand shower FlowReduce 220 mm  
- Brushed Platinum**

TARA

34 459 892

**Required miscellaneous**

	<b>Hand shower - Brushed Platinum</b>	28 012 979-06
---	---------------------------------------	---------------

**Required miscellaneous**

	<b>Hand shower - Brushed Platinum</b>	28 017 979-06
---	---------------------------------------	---------------

**Required miscellaneous**

	<b>Hand shower - Brushed Platinum</b>	28 016 979-06
---	---------------------------------------	---------------

**Required miscellaneous**

	<b>Hand shower FlowReduce - Brushed Platinum</b>	28 018 979-06 0010
---	--	-----------------------

**Required miscellaneous**

	<b>SERIES-VARIOUS Hand shower - Brushed Platinum</b>	28 029 979-06
---	--	---------------

**Required miscellaneous**

	<b>SERIES-VARIOUS Hand shower - Brushed Platinum</b>	28 025 979-06 0010
---	--	-----------------------

**Required miscellaneous**

	<b>Hand shower FlowReduce - Brushed Platinum</b>	28 016 979-06 0010
---	--	-----------------------

**Required miscellaneous**

	<b>Hand shower FlowReduce - Brushed Platinum</b>	28 012 979-06 0010
---	--	-----------------------

**Required miscellaneous**

	<b>Hand shower - Brushed Platinum</b>	28 018 979-06
---	---------------------------------------	---------------

**Required miscellaneous**

	<b>SERIES-VARIOUS Hand shower - Brushed Platinum</b>	28 029 979-06 0010
---	--	-----------------------

**Required miscellaneous**

	<b>SERIES-VARIOUS Hand shower - Brushed Platinum</b>	28 027 979-06 0010
---	--	-----------------------

**Showerpipe with shower thermostat without hand shower FlowReduce 220 mm  
- Brushed Platinum**

TARA

34 459 892  
mm [inches]  
M 1:10

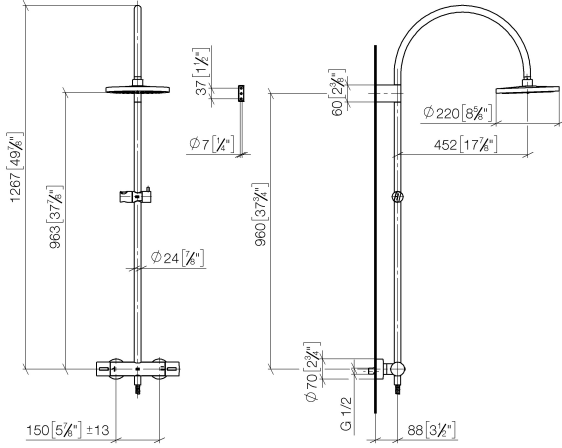

**Flow rate chart**

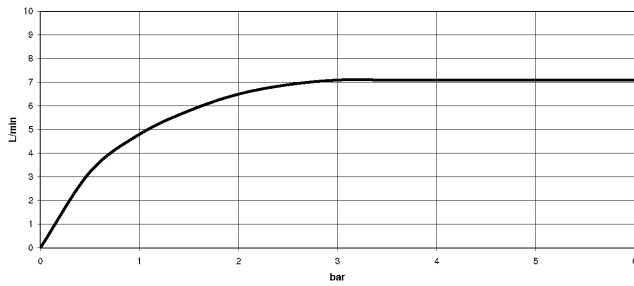

**Codes & Standards**

DIN 4109

EN 1717

ISO 3822

Scottish Water  
Byelaws

UK Water Supply  
Regulations

Ü-Zeichen



Showerpipe with shower thermostat without hand shower FlowReduce 220 mm  
- Brushed Platinum

---

TARA

34 459 892

Certificates

---

WRAS\_2204

Belgaqua\_21-032-2 LGA\_38

Showerpipe with shower thermostat without hand shower FlowReduce 220 mm  
- Brushed Platinum

TARA

34 459 892

Product version up to 9/10/2020

**Product version from 9/10/2020**

Parts for other  
finishes can be found  
here: [Chrome](#)

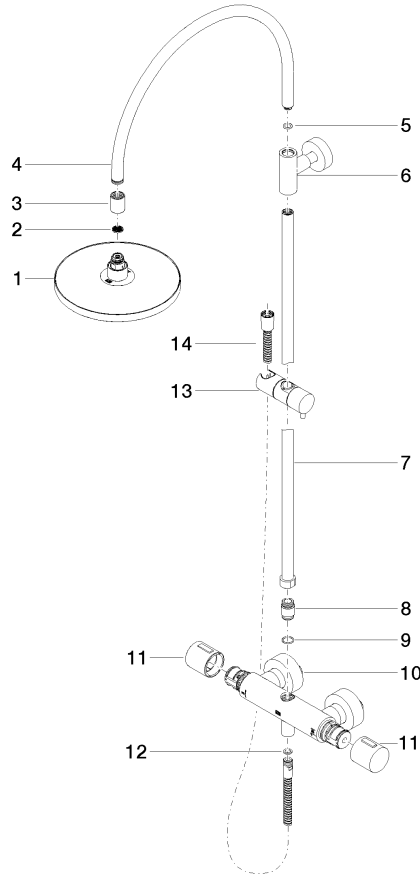



Showerpipe with shower thermostat without hand shower FlowReduce 220 mm  
- Brushed Platinum

---

TARA

34 459 892

Spare parts list

Product version up to 9/10/2020

**Product version from 9/10/2020**

No.	Item Number	Name	Quantity used	Delivery time
	04 12 05 092 00-06	shower	15	10