







MADISON Wall-mounted basin mixer without pop-up waste - Durabronss (23kt Gold)

MADISON

36 712 361



- 190mm projection
- fixed spout
- circular, air-enriched flow
- hole diameter valve 40 mm
- hole diameter spout 40 mm
- slide-on rosettes Ø 55 mm
- max. flow 7 l/min
- lead-free
- This product can help a building meet the requirements of Green Building Rating Systems, e.g. LEED®, BREEAM®, DGNB

	Durabronss (23kt Gold)	36 712 361-09
	Chrome	36 712 361-00
	Brushed Platinum	36 712 361-06
	Platinum	36 712 361-08
	Brushed Durabronss (23kt Gold)	36 712 361-28
	Brushed Dark Platinum	36 712 361-99

Required miscellaneous



Concealed wall-mounted mixer centred spout - 35 700 970 90
 •max. recess depth 145 mm
 •min. recess depth 85 mm

Required miscellaneous



Concealed wall-mounted mixer variable positioning - 35 720 970 90
 •min. recess depth 85 mm
 •max. recess depth 145 mm

36 712 361
mm [inches]

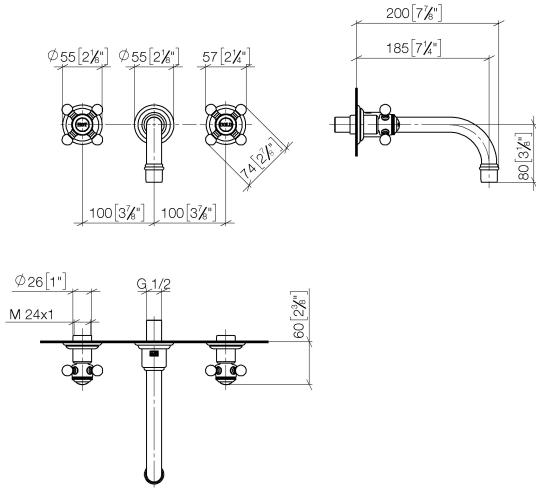

Flow rate chart



Certificates

LGA_19175.

36 712 361



36 712 361-FF

Spare parts list

No.	Item Number	Name	Quantity used	Delivery time
1	90 90 03 157 00 90	top	2	2
2	36 310 361-09	connection	2	40
3	04 20 36 100 01-09	handle (hot)	1	40
4	09 24 03 081 10 90	extension	1	2
5	90 14 10 026 00 90	seal	1	2
6	09 27 36 010-09	rosette	1	40
7	04 28 22 090 10-09	spout	1	40
8	90 14 05 020 00 90	seal	1	2
9	09 24 03 022 10-09	nipple	1	40
10	90 23 01 119 02-09	aerator	1	40
11	04 20 36 100 00-09	handle (cold)	1	40