



IMO Wall-mounted single-lever basin mixer without pop-up waste - Brushed Chrome

IMO

36 860 670



- 140mm projection
- fixed spout
- rectangular, air-enriched flow
- hole diameter spout 37 mm
- hole diameter single-lever mixer 57 mm
- rosette for spout 80 x 60mm
- rosette for mixer 80 x 80mm
- max. flow 5.7 l/min
- lead-free
- This product can help a building meet the requirements of Green Building Rating Systems, e.g. LEED®, BREEAM®, DGNB

	Brushed Chrome	36 860 670-93
	Chrome	36 860 670-00
	Brushed Platinum	36 860 670-06

36 860 670
mm [inches]

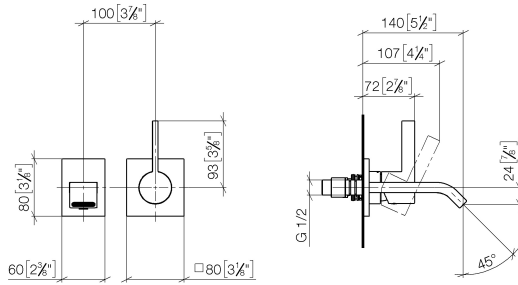

Flow rate chart



Certificates

LGA_29906.

DVGW_DW-
6512DN0435.

WRAS_2107018.

36 860 670
Parts for other finishes can be found here: Chrome

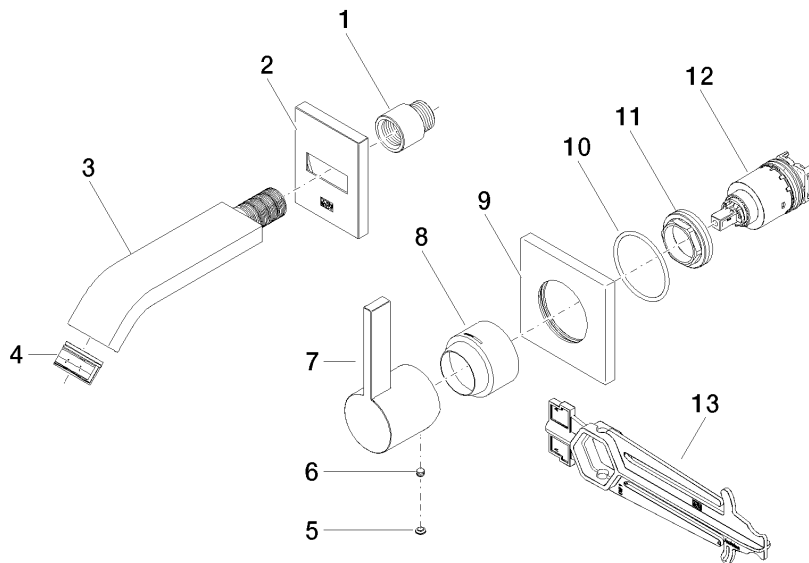

Spare parts list

No.	Item Number	Name	Quantity used	Delivery time
1	09 24 03 072 10 90	nipple	1	2
2	90 27 67 005 00-93	rosette	1	20
3	04 28 22 242 00-93	spout	1	20
4	90 29 03 109 00 90	aerator	1	2
5	90 31 20 087 00-93	plug	1	20
6	90 31 11 112 00 90	pin	1	2
7	09 20 67 004-93	handle	1	20
8	09 11 02 530-93	cover	1	20
9	09 27 78 039-93	rosette	1	20
10	90 14 10 049 00 90	seal	1	2
11	09 24 04 105 90	nut	1	2
12	90 15 05 064 01 90	cartridge	1	2
13	90 30 09 064 00 90	key	1	2