

Washstand fitting with electronic opening and closing function without pop-up waste - Chrome

TARA













44 521 660



Fits: TARA, META

- 165mm projection
- Infrared sensor technology
- height of mixer 310 mm
- height up to aerator 199 mm
- hole diameter 35 mm
- fixed spout
- max. flow 5.7 l/min
- circular, air-enriched flow
- suitable for thermal disinfection
- Automatic shut-off after pre-set time is reached
- Indirect temperature control (undercounter)
- Control box included
- Adjustable sensor detection range
- Battery or plug-in power supply operated (batteries not included)
- 4x AA (1.5V) batteries required
- lead-free
- 1x screw-in M 8 x 1 pressure hose, leak-tested
- This product can help a building meet the requirements of Green Building Rating Systems, e.g. LEED®, BREEAM®, DGNB
- WRAS 2211011

Batteries not included

	Chrome	44 521 660-00
	Brushed Platinum	44 521 660-06
	Platinum	44 521 660-08
	Dark Chrome	44 521 660-19
	Light Gold	44 521 660-26
	Brushed Light Gold	44 521 660-27
	Brushed Durabronze (23kt Gold)	44 521 660-28
	Matte Black	44 521 660-33
	Brushed Bronze	44 521 660-42
	Brushed Champagne (22kt Gold)	44 521 660-46
	Champagne (22kt Gold)	44 521 660-47
	Brushed Chrome	44 521 660-93
	Brushed Dark Platinum	44 521 660-99

44 521 660

mm [inches]

1:5

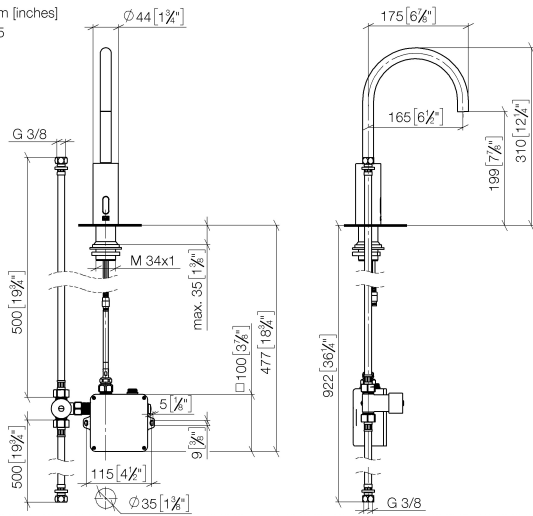

Flow rate chart

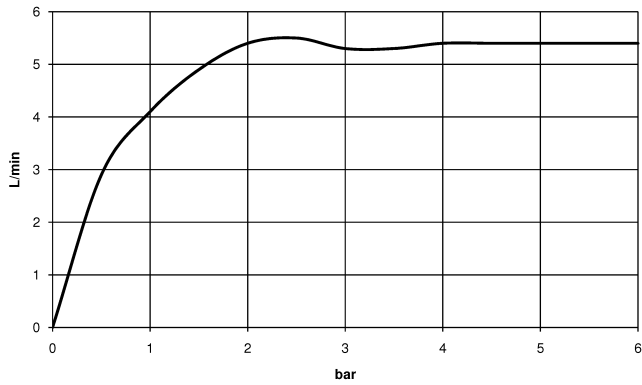

Certificates

Belgaqua\_23-210- 27\_1. LGA\_38245. WRAS\_2211011. GDV\_0400278.

44 521 660

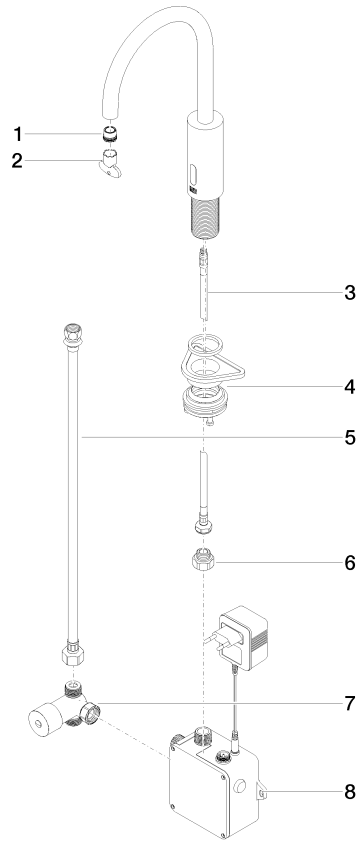

### Spare parts list

No.	Item Number	Name	Quantity used	Delivery time
1	09 29 03 126 90	aerator	1	2
2	90 30 09 028 00 90	key	1	2
3	04 30 04 100 00 90	hose	1	2
4	04 23 10 044 08 90	fixing set	1	2
5	12 506 970 90	High pressure hoses -	1	2
6	09 24 03 185-00	nipple	1	10
7	90 30 50 081 00 90	valve	1	2
8	90 10 01 247 00 90	valve box	1	10