







MADISON Three-hole basin mixer with pop-up waste - Brushed Durabronz (23kt Gold)

MADISON

ST 010 107 7370



- 135mm projection
- fixed spout
- circular, air-enriched flow
- height of mixer 72 mm
- height up to aerator 40 mm
- hole diameter valve 32 mm
- hole diameter spout 35 mm
- without rosette
- 2x 1/2" x 1/2" high pressure hose
- max. flow 7 l/min
- lead-free
- This product can help a building meet the requirements of Green Building Rating Systems, e.g. LEED®, BREEAM®, DGNB

| | | |
|--|-------------------------------|--------------------|
|  | Brushed Durabronz (23kt Gold) | ST 010 107 7370-28 |
|  | Chrome | ST 010 107 7370-00 |
|  | Brushed Platinum | ST 010 107 7370-06 |
|  | Platinum | ST 010 107 7370-08 |
|  | Durabronz (23kt Gold) | ST 010 107 7370-09 |
|  | Brushed Dark Platinum | ST 010 107 7370-99 |

Individual components of this set

You need the following components for this set

2x 11 170 370-28



1x 20 700 370-28





MADISON Three-hole basin mixer with pop-up waste - Brushed Durabrass
(23kt Gold)

MADISON

ST 010 107 7370

**MADISON Three-hole basin mixer with pop-up waste - Brushed Durabronz
(23kt Gold)**









MADISON

ST 010 107 7370

- for basin fittings

NOTE: Mixers are supplied without lever inserts.
Please order the lever inserts separately!



| | | |
|--|-------------------------------|---------------|
|  | Brushed Durabronz (23kt Gold) | 11 170 370-28 |
|  | Chrome | 11 170 370-00 |
|  | Gold (23.9kt) | 11 170 370-01 |
|  | Brushed Platinum | 11 170 370-06 |
|  | Platinum | 11 170 370-08 |
|  | Durabronz (23kt Gold) | 11 170 370-09 |
|  | white | 11 170 370-12 |
|  | black | 11 170 370-13 |
|  | Brushed Dark Platinum | 11 170 370-99 |

ST 010 107 7370

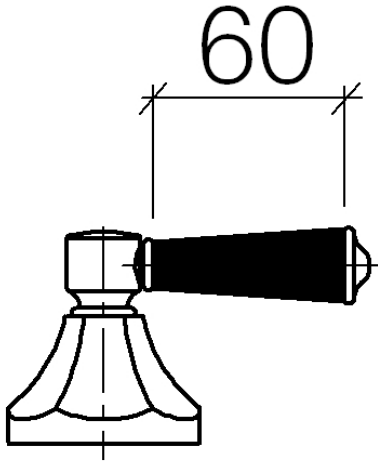



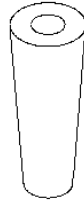



ST 010 107 7370
Parts for other finishes can be found here: Chrome



- 135mm projection
- fixed spout
- circular, air-enriched flow
- height of mixer 72 mm
- height up to aerator 40 mm
- hole diameter valve 32 mm
- hole diameter spout 35 mm
- without rosette
- 2x 1/2" x 1/2" high pressure hose
- max. flow 7 l/min
- lead-free
- This product can help a building meet the requirements of Green Building Rating Systems, e.g. LEED®, BREEAM®, DGNB

Only suitable for basins with an overflow.

| | | |
|--|------------------------------|---------------|
|  | Brushed Durabron (23kt Gold) | 20 700 370-28 |
|  | Chrome | 20 700 370-00 |
|  | Brushed Platinum | 20 700 370-06 |
|  | Platinum | 20 700 370-08 |
|  | Durabron (23kt Gold) | 20 700 370-09 |
|  | Brushed Dark Platinum | 20 700 370-99 |



MADISON Three-hole basin mixer with pop-up waste - Brushed Durabrass
(23kt Gold)

MADISON

ST 010 107 7370

ST 010 107 7370
mm [inches]

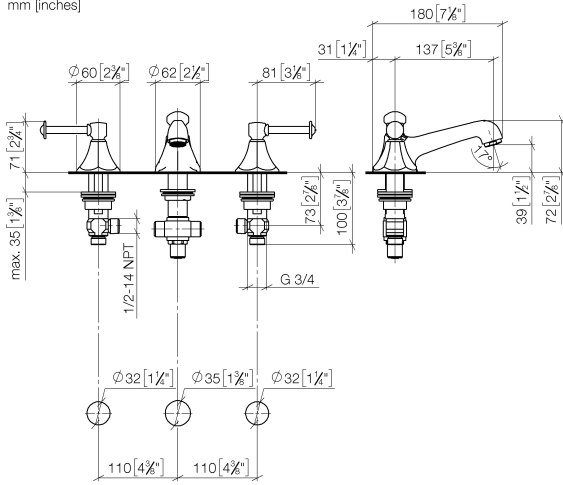

Flow rate chart

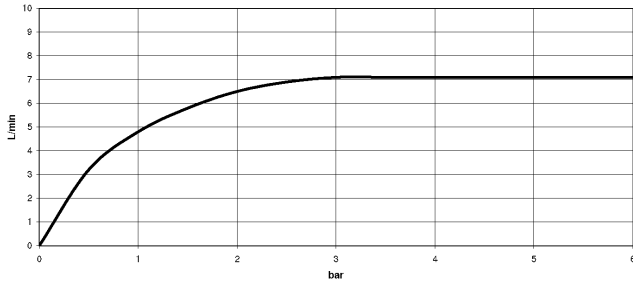

Certificates

GDV_0400288. LGA_8027.

ST 010 107 7370
Parts for other finishes can be found here: Chrome

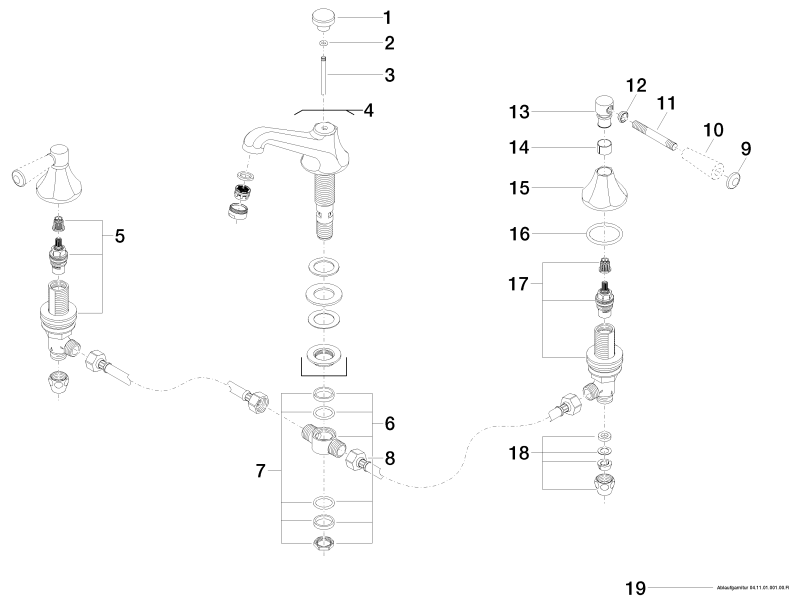

Spare parts list

| No. | Item Number | Name | Quantity used | Delivery time |
|--|--------------------|---|---------------|---------------|
| 1 | 09 20 36 030-28 | handle | 1 | 20 |
| 2 | 90 14 10 062 00 90 | seal | 1 | 2 |
| 3 | 09 31 09 004-28 | pull-rod | 1 | 20 |
| 4 | 13 700 380-28 | spout | 1 | - |
| Spare part can no longer be ordered, please order the replacement item | | | | |
| 5 | 90 17 11 040 51 90 | side panel | 1 | 2 |
| 6 | 90 17 11 020 10 90 | distributor | 1 | 2 |
| 7 | 90 23 10 012 00 90 | gasket kit | 1 | 2 |
| 8 | 04 30 04 096 00 90 | hose | 2 | 2 |
| 9 | 09 30 30 062-28 | screw | 2 | 20 |
| 10 | 11 170 370-28 | MADISON Lever insert - Brushed Durabron (23kt Gold) | 2 | 20 |
| 11 | 09 28 22 013 90 | pipe | 2 | 2 |
| 12 | 09 20 37 001-28 | handle | 2 | 20 |
| 13 | 09 20 82 000-28 | handle | 2 | 20 |
| 14 | 90 18 40 041 00 90 | sleeve | 2 | 2 |
| 15 | 09 27 37 014-28 | rosette | 2 | 20 |
| 16 | 90 14 10 043 00 90 | seal | 2 | 2 |
| 17 | 90 17 11 040 50 90 | side panel | 1 | 2 |
| 18 | 90 23 30 040 00-28 | threaded connector | 2 | 20 |
| 19 | 90 11 01 001 00-28 | pop-up waste | 1 | 20 |