

# Shower set - Champagne (22kt Gold)

ST 050 203 2979



Fits: IMO, LISSÉ, META

- slide bar
- Pipe diameter 18 mm
- gauge 853 mm
- metal shower hose 1750mm with integrated anti-twist protection
- shower hose connector 3/8"
- Three or five settings: COMPACT RAIN, COMPACT SOFT FLOW, COMPACT AQUAPRESSURE FLOW, max. flow rate 6.8 l/min (at 3 bar)
- Function from: 6 l/min
- spray head Ø 100mm
- This product can help a building meet the requirements of Green Building Rating Systems, e.g. LEED®, BREEAM®, DGNB

|  |                                |                         |
|--|--------------------------------|-------------------------|
|  | Champagne (22kt Gold)          | ST 050 203 2979-47 0010 |
|  | Chrome                         | ST 050 203 9979-00      |
|  | Chrome                         | ST 050 203 2979-00 0010 |
|  | Brushed Platinum               | ST 050 203 9979-06      |
|  | Brushed Platinum               | ST 050 203 2979-06 0010 |
|  | Platinum                       | ST 050 203 9979-08      |
|  | Platinum                       | ST 050 203 2979-08 0010 |
|  | Dark Chrome                    | ST 050 203 9979-19      |
|  | Dark Chrome                    | ST 050 203 2979-19 0010 |
|  | Light Gold                     | ST 050 203 2979-26 0010 |
|  | Light Gold                     | ST 050 203 9979-26      |
|  | Brushed Light Gold             | ST 050 203 9979-27      |
|  | Brushed Light Gold             | ST 050 203 2979-27 0010 |
|  | Brushed Durabronze (23kt Gold) | ST 050 203 9979-28      |
|  | Brushed Durabronze (23kt Gold) | ST 050 203 2979-28 0010 |
|  | Matte Black                    | ST 050 203 9979-33      |
|  | Matte Black                    | ST 050 203 2979-33 0010 |
|  | Brushed Bronze                 | ST 050 203 2979-42 0010 |
|  | Brushed Bronze                 | ST 050 203 9979-42      |
|  | Brushed Champagne (22kt Gold)  | ST 050 203 9979-46      |
|  | Brushed Champagne (22kt Gold)  | ST 050 203 2979-46 0010 |
|  | Champagne (22kt Gold)          | ST 050 203 9979-47      |
|  | Brushed Chrome                 | ST 050 203 9979-93      |
|  | Brushed Chrome                 | ST 050 203 2979-93 0010 |
|  | Brushed Dark Platinum          | ST 050 203 9979-99      |
|  | Brushed Dark Platinum          | ST 050 203 2979-99 0010 |

## Shower set - Champagne (22kt Gold)

IMO

ST 050 203 2979

### Individual components of this set

You need the following components for this set



1x

26 413 979-47



1x

28 018 979-47 0010



## Shower set - Champagne (22kt Gold)

---

IMO

ST 050 203 2979

## Shower set - Champagne (22kt Gold)

IMO













ST 050 203 2979



Fits: IMO, LULU, MEM, TARA, CL.1, LISSÉ,  
VAIA, META, CYO

- slide bar
- Pipe diameter 18 mm
- gauge 853 mm
- metal shower hose 1750mm with integrated anti-twist protection
- shower hose connector 3/8"
- WRAS 2009048

This article does not include a hand shower!

|  |                                |               |
|--|--------------------------------|---------------|
|    | Champagne (22kt Gold)          | 26 413 979-47 |
|    | Chrome                         | 26 413 979-00 |
|    | Brushed Platinum               | 26 413 979-06 |
|    | Platinum                       | 26 413 979-08 |
|    | Dark Chrome                    | 26 413 979-19 |
|    | Light Gold                     | 26 413 979-26 |
|    | Brushed Light Gold             | 26 413 979-27 |
|    | Brushed Durabronze (23kt Gold) | 26 413 979-28 |
|    | Matte Black                    | 26 413 979-33 |
|    | Brushed Bronze                 | 26 413 979-42 |
|   | Brushed Champagne (22kt Gold)  | 26 413 979-46 |
|  | Brushed Chrome                 | 26 413 979-93 |
|  | Brushed Dark Platinum          | 26 413 979-99 |

### Recommended miscellaneous



**Wall elbow - Champagne (22kt Gold)** 28 450 980-47

ST 050 203 2979

mm [inches]

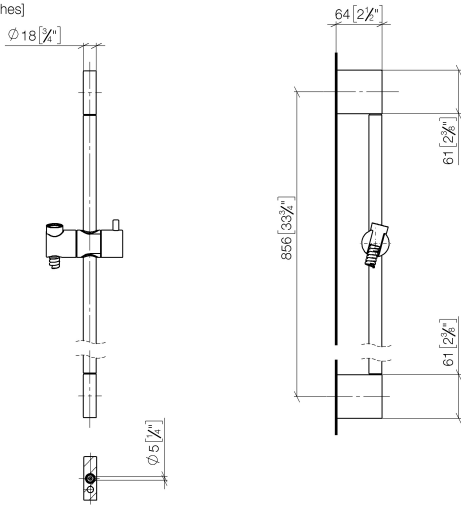

ST 050 203 2979

Parts for other finishes can be found here: [Chrome](#)

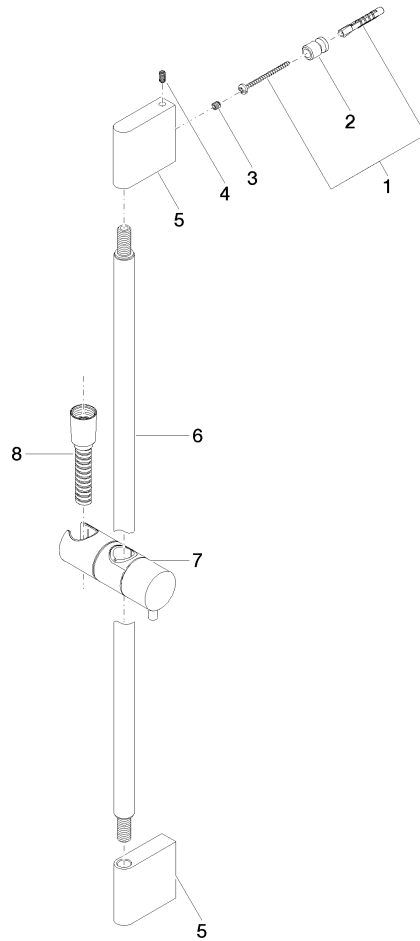

**Spare parts list**

| No. | Item Number        | Name  | Quantity used | Delivery time |
|-----|--------------------|---|---------------|---------------|
| 1   | 05 17 20 726 02 90 | fixing set  | 2             | 2             |
| 2   | 08 17 20 726 90    | holder  | 2             | 2             |
| 3   | 09 31 11 049 90    | pin   | 2             | 2             |
| 4   | 04 31 11 113 00 90 | pin   | 2             | 2             |
| 5   | 08 17 97 054-47    | holder  | 2             | 30            |
| 6   | 90 28 22 597 00-47 | holder  | 1             | 30            |
| 7   | 12 580 970-47      | Slide unit - Champagne (22kt Gold)                              | 1             | 30            |
| 8   | 28 322 970-47      | Metal shower hose 1/2" x 3/8" x 1750 mm - Champagne (22kt Gold) | 1             | 30            |

# Shower set - Champagne (22kt Gold)

IMO

ST 050 203 2979



- Three or five settings: COMPACT RAIN, COMPACT SOFT FLOW, COMPACT AQUAPRESSURE FLOW, max. flow rate 6.8 l/min (at 3 bar)
- with anti-scale system
- spray head Ø 100mm
- 1/2" connection
- Function from: 6 l/min
- This product can help a building meet the requirements of Green Building Rating Systems, e.g. LEED®, BREEAM®, DGNB

Intrinsic protection against back flow.

Fits: IMO, LULU, MADISON, MEM, TARA, CL.1, LISSÉ, VAIA, META, CYO

|  |                                |                    |
|--|--------------------------------|--------------------|
|  | Champagne (22kt Gold)          | 28 018 979-47 0010 |
|  | Chrome                         | 28 018 979-00      |
|  | Chrome                         | 28 018 979-00 0010 |
|  | Brushed Platinum               | 28 018 979-06      |
|  | Brushed Platinum               | 28 018 979-06 0010 |
|  | Platinum                       | 28 018 979-08      |
|  | Platinum                       | 28 018 979-08 0010 |
|  | Dark Brass matt                | 28 018 979-16 0010 |
|  | Dark Bronze matt               | 28 018 979-17 0010 |
|  | Dark Chrome                    | 28 018 979-19      |
|  | Dark Chrome                    | 28 018 979-19 0010 |
|  | Light Gold                     | 28 018 979-26 0010 |
|  | Light Gold                     | 28 018 979-26      |
|  | Brushed Light Gold             | 28 018 979-27 0010 |
|  | Brushed Light Gold             | 28 018 979-27      |
|  | Brushed Durabronze (23kt Gold) | 28 018 979-28      |
|  | Brushed Durabronze (23kt Gold) | 28 018 979-28 0010 |
|  | Matte Black                    | 28 018 979-33      |
|  | Matte Black                    | 28 018 979-33 0010 |
|  | Brushed Bronze                 | 28 018 979-42 0010 |
|  | Brushed Bronze                 | 28 018 979-42      |
|  | Brushed Champagne (22kt Gold)  | 28 018 979-46      |
|  | Brushed Champagne (22kt Gold)  | 28 018 979-46 0010 |
|  | Champagne (22kt Gold)          | 28 018 979-47      |
|  | Brushed Chrome                 | 28 018 979-93      |
|  | Brushed Chrome                 | 28 018 979-93 0010 |
|  | Brushed Dark Platinum          | 28 018 979-99      |
|  | Brushed Dark Platinum          | 28 018 979-99 0010 |



## Shower set - Champagne (22kt Gold)

---

IMO

ST 050 203 2979







## Shower set - Champagne (22kt Gold)

---

IMO

ST 050 203 2979

ST 050 203 2979

mm [inches]

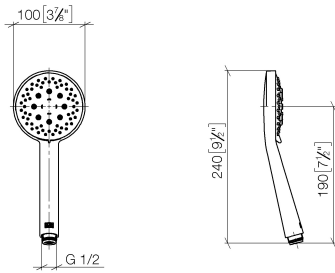

Flow rate chart

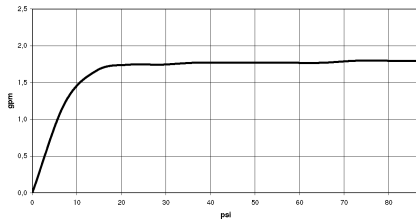

Certificates

LGA\_29984.

Spare parts list

| No. | Item Number     | Name  | Quantity used | Delivery time |
|-----|-----------------|-------|---------------|---------------|
| 1   | 09 23 01 039 90 | sieve | 1             | 2             |