

ST 050 303 4892



- shower with fixed riser projection 420mm
- Rain shower: PURE RAIN, max. flow rate 7 l/min (at 3 bar)
- rain shower Ø 220 mm
- rain shower with anti-scale system
- Hand shower: COMPACT RAIN, max. flow rate 15 l/min (at 3 bar)
- spray head Ø 100mm
- rotary diverter for fixed-riser shower/hand shower
- height of fittings up to rain shower (bottom edge) 1007mm
- height of fittings up to top edge of elbow 1167mm
- rosette for shower holder Ø 55mm
- rosette for wall mounting Ø 57mm
- rosette for shower mixer Ø 65mm
- gauge 150 mm - 13 mm
- 1500 mm metal shower hose
- 1/2" connection
- Pipe diameter 20 mm

	Matte Black	ST 050 303 4892-33
	Chrome	ST 050 303 4892-00
	Brushed Platinum	ST 050 303 4892-06
	Platinum	ST 050 303 4892-08
	Dark Chrome	ST 050 303 4892-19
	Brushed Light Gold	ST 050 303 4892-27
	Brushed Durabronze (23kt Gold)	ST 050 303 4892-28
	Brushed Bronze	ST 050 303 4892-42
	Brushed Champagne (22kt Gold)	ST 050 303 4892-46
	Champagne (22kt Gold)	ST 050 303 4892-47
	Brushed Chrome	ST 050 303 4892-93
	Brushed Dark Platinum	ST 050 303 4892-99

Individual components of this set

You need the following components for this set



1x 26 633 892-33



1x 28 018 979-33



TARA Showerpipe 220 mm - Matte Black

TARA

ST 050 303 4892

ST 050 303 4892



- shower with fixed riser projection 420mm
- overhead shower: rain flow
- rain shower Ø 220 mm
- rain shower with anti-scale system
- max. rainshower flow 7 l/min
- rotary diverter for fixed-riser shower/hand shower
- height of fittings up to rain shower (bottom edge) 1007mm
- height of fittings up to top edge of elbow 1167mm
- rosette for shower holder Ø 55mm
- rosette for wall mounting Ø 57mm
- rosette for shower mixer Ø 65mm
- gauge 150 mm - 13 mm
- 1500 mm metal shower hose
- 1/2" connection
- Pipe diameter 20 mm
- quick clearing
- This product can help a building meet the requirements of Green Building Rating Systems, e.g. LEED®, BREEAM®, DGNB
- WRAS 2204012

This article does not include a hand shower!
Intrinsic protection against back flow.

	Matte Black	26 633 892-33
	Chrome	26 633 892-00
	Brushed Platinum	26 633 892-06
	Platinum	26 633 892-08
	Dark Chrome	26 633 892-19
	Brushed Durabronze (23kt Gold)	26 633 892-28
	Brushed Champagne (22kt Gold)	26 633 892-46
	Champagne (22kt Gold)	26 633 892-47
	Brushed Chrome	26 633 892-93
	Brushed Dark Platinum	26 633 892-99

Required miscellaneous

	Hand shower - Matte Black	28 015 979-33
--	----------------------------------	---------------

Required miscellaneous

	Hand shower - Matte Black	28 017 979-33
--	----------------------------------	---------------

Required miscellaneous

	Hand shower - Matte Black	28 012 979-33
--	----------------------------------	---------------

Required miscellaneous

	Hand shower - Matte Black	28 018 979-33
--	----------------------------------	---------------

Required miscellaneous

	Hand shower FlowReduce - Matte Black	28 012 979-33 0010
--	---	-----------------------

Required miscellaneous

	Hand shower - Matte Black	28 016 979-33
--	----------------------------------	---------------

Required miscellaneous

	Hand shower FlowReduce - Matte Black	28 016 979-33 0010
--	---	-----------------------

Required miscellaneous

	Hand shower FlowReduce - Matte Black	28 018 979-33 0010
--	---	-----------------------

Flow rate chart

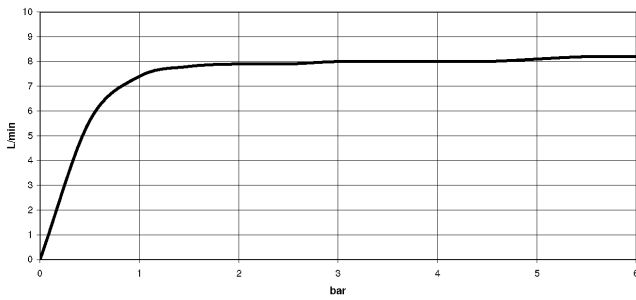

Certificates

Belgaqua_21-023- WRAS_2204012. LGA_38735.
27_8.

ST 050 303 4892

Parts for other finishes can be found here: [Chrome](#)

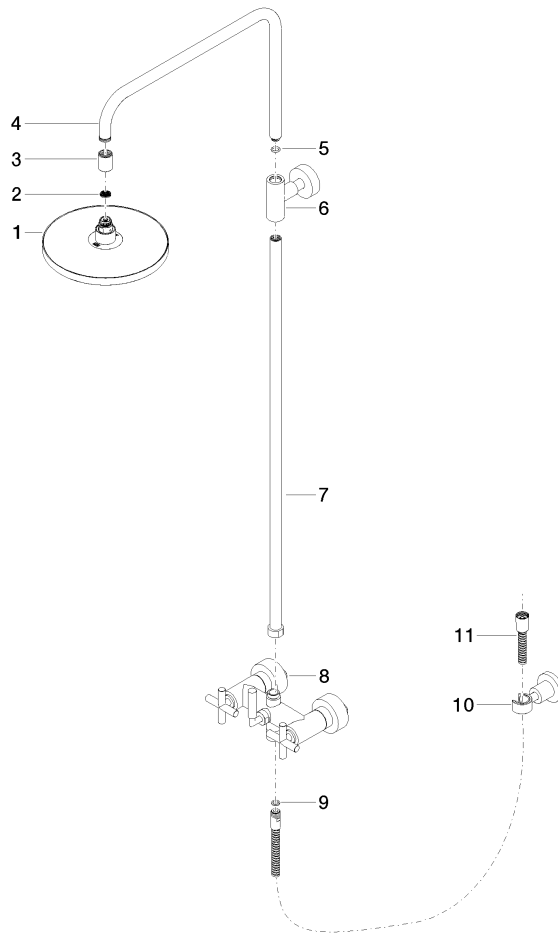

Spare parts list

No.	Item Number	Name	Quantity used	Delivery time
1	90 12 05 092 20-33	shower	1	30
2	09 23 01 039 90	sieve	1	2
3	09 24 03 177 20-33	adaptor	1	30
4	04 28 22 101 20-33	spout	1	30
5	90 14 10 011 00 90	seal	1	2
6	90 17 11 037 00-33	holder	1	-
Spare part can no longer be ordered, please order the replacement item				
7	90 28 22 096 00-33	pipe	1	30
8	04 17 10 020 01-33	fitting	1	30
9	90 14 20 026 00 90	seal	1	2
10	28 050 892-33	TARA Wall bracket - Matte Black	1	10
11	28 304 970-33	Metal shower hose 1/2" x 3/8" x 1500 mm - Matte Black	1	30





























ST 050 303 4892



- Three or five settings: COMPACT RAIN, COMPACT SOFT FLOW, COMPACT AQUAPRESSURE FLOW, max. flow rate 15 l/min (at 3 bar)
- with anti-scale system
- spray head Ø 100mm
- 1/2" connection
- WRAS 2210003
- Function from: 7 l/min

Intrinsic protection against back flow.

Fits: IMO, LULU, MADISON, MEM, TARA, CL.1, LISSÉ, VAIA, META, CYO

	Matte Black	28 018 979-33
	Chrome	28 018 979-00
	Chrome	28 018 979-00 0010
	Brushed Platinum	28 018 979-06
	Brushed Platinum	28 018 979-06 0010
	Platinum	28 018 979-08
	Platinum	28 018 979-08 0010
	Dark Brass matt	28 018 979-16 0010
	Dark Bronze matt	28 018 979-17 0010
	Dark Chrome	28 018 979-19
	Dark Chrome	28 018 979-19 0010
	Light Gold	28 018 979-26 0010
	Light Gold	28 018 979-26
	Brushed Light Gold	28 018 979-27 0010
	Brushed Light Gold	28 018 979-27
	Brushed Durabrass (23kt Gold)	28 018 979-28
	Brushed Durabrass (23kt Gold)	28 018 979-28 0010
	Matte Black	28 018 979-33 0010
	Brushed Bronze	28 018 979-42 0010
	Brushed Bronze	28 018 979-42
	Brushed Champagne (22kt Gold)	28 018 979-46
	Brushed Champagne (22kt Gold)	28 018 979-46 0010
	Champagne (22kt Gold)	28 018 979-47
	Champagne (22kt Gold)	28 018 979-47 0010
	Brushed Chrome	28 018 979-93
	Brushed Chrome	28 018 979-93 0010
	Brushed Dark Platinum	28 018 979-99
	Brushed Dark Platinum	28 018 979-99 0010



TARA Showerpipe 220 mm - Matte Black

TARA

ST 050 303 4892



TARA Showerpipe 220 mm - Matte Black

TARA

ST 050 303 4892



TARA Showerpipe 220 mm - Matte Black

TARA

ST 050 303 4892

ST 050 303 4892

mm [inches]



Flow rate chart



Certificates

LGA_29984.

DVGW_DW-
6517DN0129.

WRAS_2210003.

ST 050 303 4892

Parts for other
finishes can be found
here: [Chrome](#)



Spare parts list

No.	Item Number	Name	Quantity used	Delivery time
1	09 23 01 039 90	sieve	1	2