

ST 050 305 1979



Fits: IMO, LULU, TARA, LISSÉ, VAIA, META, CYO

- shower with fixed riser projection 453mm
- Rain shower: PURE RAIN, max. flow rate 7 l/min (at 3 bar)
- rain shower Ø 220 mm
- rain shower with anti-scale system
- Hand shower: COMPACT RAIN, max. flow rate 15 l/min (at 3 bar)
- spray head Ø 100mm
- rotary diverter with volume control and shut-off function
- slide-on rosettes Ø 70 mm
- height of fittings up to rain shower (bottom edge) 1009mm
- height of fittings up to top edge of elbow 1150mm
- gauge 150 mm - 13 mm
- metal shower hose 1750mm with integrated anti-twist protection
- 1/2" connection
- slide bar
- Pipe diameter 23.5 mm

	Brushed Durabron (23kt Gold)	ST 050 305 1979-28
	Chrome	ST 050 305 1979-00
	Brushed Platinum	ST 050 305 1979-06
	Platinum	ST 050 305 1979-08
	Dark Chrome	ST 050 305 1979-19
	Matte Black	ST 050 305 1979-33
	Brushed Champagne (22kt Gold)	ST 050 305 1979-46
	Champagne (22kt Gold)	ST 050 305 1979-47
	Brushed Dark Platinum	ST 050 305 1979-99

Individual components of this set

You need the following components for this set



1x 34 459 979-28



1x 28 015 979-28



Showerpipe with shower thermostat - Brushed Durabronz (23kt Gold)

IMO

ST 050 305 1979

ST 050 305 1979



Fits: IMO, LULU, TARA, LISSÉ, VAIA, META

- shower with fixed riser projection 453mm
- overhead shower: rain flow
- rain shower Ø 220 mm
- rain shower with anti-scale system
- max. rainshower flow 7 l/min
- rotary diverter with volume control and shut-off function
- slide-on rosettes Ø 70 mm
- height of fittings up to rain shower (bottom edge) 1009mm
- height of fittings up to top edge of elbow 1150mm
- gauge 150 mm - 13 mm
- metal shower hose 1750mm with integrated anti-twist protection
- 1/2" connection
- slide bar
- Pipe diameter 23.5 mm
- quick clearing
- This product can help a building meet the requirements of Green Building Rating Systems, e.g. LEED®, BREEAM®, DGNB
- WRAS 2204013

This article does not include a hand shower!

Intrinsic protection against back flow.

	Brushed Durabronze (23kt Gold)	34 459 979-28
	Chrome	34 459 979-00
	Brushed Platinum	34 459 979-06
	Platinum	34 459 979-08
	Dark Chrome	34 459 979-19
	Light Gold	34 459 979-26
	Brushed Light Gold	34 459 979-27
	Matte Black	34 459 979-33
	Brushed Bronze	34 459 979-42
	Brushed Champagne (22kt Gold)	34 459 979-46
	Champagne (22kt Gold)	34 459 979-47
	Brushed Chrome	34 459 979-93
	Brushed Dark Platinum	34 459 979-99

Required miscellaneous

Hand shower - Brushed Durabronze (23kt Gold) 28 016 979-28

Required miscellaneous

Hand shower - Brushed Durabronze (23kt Gold) 28 017 979-28

Required miscellaneous

Hand shower - Brushed Durabronze (23kt Gold) 28 018 979-28

Required miscellaneous

Hand shower - Brushed Durabronze (23kt Gold) 28 012 979-28

Required miscellaneous

Hand shower FlowReduce - Brushed Durabronze (23kt Gold) 28 012 979-28 0010

Required miscellaneous

Hand shower FlowReduce - Brushed Durabronze (23kt Gold) 28 016 979-28 0010

Required miscellaneous

Hand shower FlowReduce - Brushed Durabronze (23kt Gold) 28 018 979-28 0010

ST 050 305 1979

mm [inches]
1:10

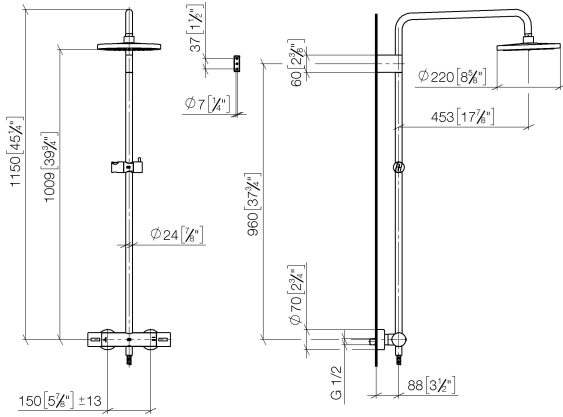

Flow rate chart

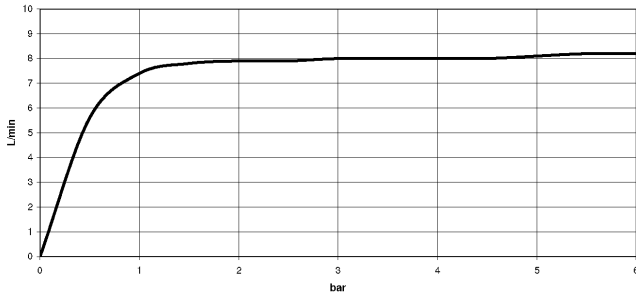

Certificates

DVGW_DW-6509DN0123. Belgaqua_21-032-27_5. WRAS_2204013. LGA_38737.

ST 050 305 1979

Parts for other finishes can be found here: [Chrome](#)

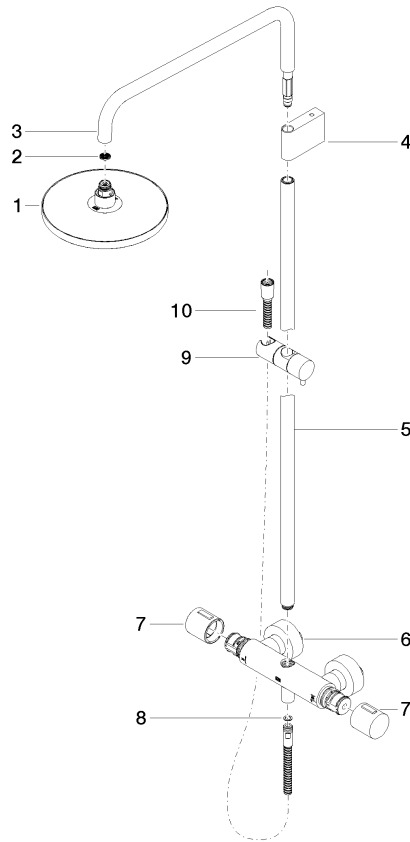

Spare parts list

No.	Item Number	Name	Quantity used	Delivery time
1	90 12 05 092 20-28	shower	1	20
2	09 23 01 039 90	sieve	1	2
3	90 28 22 348 00-28	pipe	1	20
4	90 17 11 150 00-28	holder	1	20
5	90 28 22 349 00-28	pipe	1	20
6	04 17 01 250 00-28	connection	1	20
7	90 17 33 015 00-28	handle	2	20
8	90 14 20 026 00 90	seal	1	2
9	12 570 970-28	Slide unit - Brushed Durabronz (23kt Gold)	1	20
10	28 322 970-28	Metal shower hose 1/2" x 3/8" x 1750 mm - Brushed Durabronz (23kt Gold)	1	20

Showerpipe with shower thermostat - Brushed Durabrass (23kt Gold)

IMO



























ST 050 305 1979



- COMPACT RAIN, max. flow rate 15 l/min (at 3 bar)
- with anti-scale system
- spray head Ø 100mm
- 1/2" connection
- WRAS 2009011

Intrinsic protection against back flow.

Fits: IMO, LULU, MADISON, MEM, TARA, CL.1, LISSÉ, VAIA, META, CYO

	Brushed Durabrass (23kt Gold)	28 015 979-28
	Chrome	28 015 979-00
	Chrome	28 015 979-00 0010
	Brushed Platinum	28 015 979-06
	Brushed Platinum	28 015 979-06 0010
	Platinum	28 015 979-08
	Platinum	28 015 979-08 0010
	Dark Chrome	28 015 979-19
	Dark Chrome	28 015 979-19 0010
	Light Gold	28 015 979-26 0010
	Light Gold	28 015 979-26
	Brushed Light Gold	28 015 979-27 0010
	Brushed Light Gold	28 015 979-27
	Brushed Durabrass (23kt Gold)	28 015 979-28 0010
	Matte Black	28 015 979-33
	Matte Black	28 015 979-33 0010
	Brushed Bronze	28 015 979-42
	Brushed Bronze	28 015 979-42 0010
	Brushed Champagne (22kt Gold)	28 015 979-46
	Brushed Champagne (22kt Gold)	28 015 979-46 0010
	Champagne (22kt Gold)	28 015 979-47
	Champagne (22kt Gold)	28 015 979-47 0010
	Brushed Chrome	28 015 979-93
	Brushed Chrome	28 015 979-93 0010
	Brushed Dark Platinum	28 015 979-99
	Brushed Dark Platinum	28 015 979-99 0010



Showerpipe with shower thermostat - Brushed Durabronz (23kt Gold)

IMO

ST 050 305 1979



Showerpipe with shower thermostat - Brushed Durabronz (23kt Gold)

IMO

ST 050 305 1979



Showerpipe with shower thermostat - Brushed Durabronze (23kt Gold)

IMO

ST 050 305 1979

ST 050 305 1979

mm [inches]

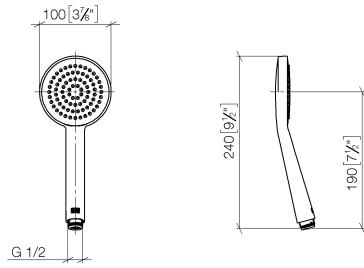

Flow rate chart

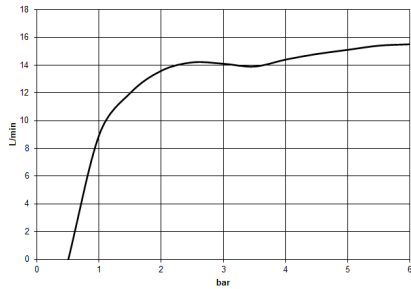

Certificates

DVGW_DW-6517DN0129. WRAS_2009011. LGA_29981.

ST 050 305 1979

Parts for other
finishes can be found
here: [Chrome](#)

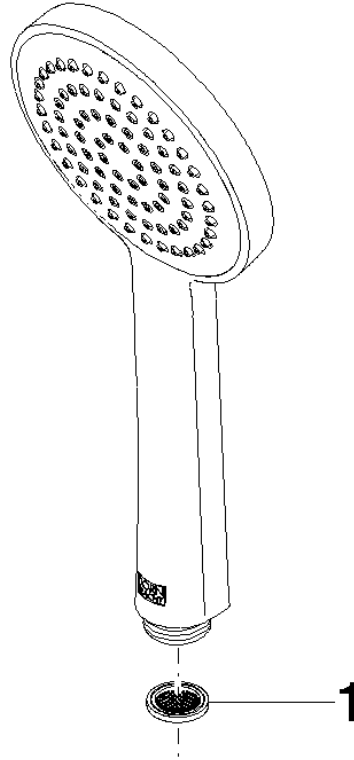

Spare parts list

No.	Item Number	Name	Quantity used	Delivery time
1	09 23 01 039 90	sieve	1	2