

Showerpipe with single-lever shower mixer - Matte Black

IMO

ST 050 306 7979



Fits: IMO, LULU, TARA, LISSÉ, VAIA, META, CYO

- shower with fixed riser projection 450mm
 - Rain shower: PURE RAIN, max. flow rate 14 l/min (at 3 bar)
 - rain shower Ø 220 mm
 - rain shower with anti-scale system
 - Hand shower: COMPACT RAIN, max. flow rate 15 l/min (at 3 bar)
 - spray head Ø 100mm
 - height of fittings up to rain shower (bottom edge) 1010mm
 - height of fittings up to top edge of elbow 1150mm
 - metal shower hose 1750mm with integrated anti-twist protection
 - 1/2" connection
 - slide bar
 - Pipe diameter 23.5 mm
 - automatic diverter for fixed-riser shower/hand shower
- Intrinsic protection against back flow.**

	Matte Black	ST 050 306 7979-33
	Chrome	ST 050 306 7979-00
	Brushed Platinum	ST 050 306 7979-06
	Platinum	ST 050 306 7979-08
	Dark Chrome	ST 050 306 7979-19
	Brushed Durabronze (23kt Gold)	ST 050 306 7979-28
	Brushed Champagne (22kt Gold)	ST 050 306 7979-46
	Champagne (22kt Gold)	ST 050 306 7979-47
	Brushed Dark Platinum	ST 050 306 7979-99

Individual components of this set

You need the following components for this set

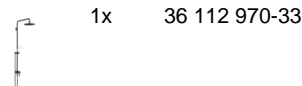
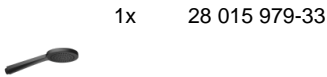



Showerpipe with single-lever shower mixer - Matte Black

IMO

ST 050 306 7979

Showerpipe with single-lever shower mixer - Matte Black

IMO



























ST 050 306 7979



- COMPACT RAIN, max. flow rate 15 l/min (at 3 bar)
- with anti-scale system
- spray head Ø 100mm
- 1/2" connection
- WRAS 2009011

Intrinsic protection against back flow.

Fits: IMO, LULU, MADISON, MEM, TARA,
CL.1, LISSÉ, VAIA, META, CYO

	Matte Black	28 015 979-33
	Chrome	28 015 979-00
	Chrome	28 015 979-00 0010
	Brushed Platinum	28 015 979-06
	Brushed Platinum	28 015 979-06 0010
	Platinum	28 015 979-08
	Platinum	28 015 979-08 0010
	Dark Chrome	28 015 979-19
	Dark Chrome	28 015 979-19 0010
	Light Gold	28 015 979-26 0010
	Light Gold	28 015 979-26
	Brushed Light Gold	28 015 979-27 0010
	Brushed Light Gold	28 015 979-27
	Brushed Durabronze (23kt Gold)	28 015 979-28
	Brushed Durabronze (23kt Gold)	28 015 979-28 0010
	Matte Black	28 015 979-33 0010
	Brushed Bronze	28 015 979-42
	Brushed Bronze	28 015 979-42 0010
	Brushed Champagne (22kt Gold)	28 015 979-46
	Brushed Champagne (22kt Gold)	28 015 979-46 0010
	Champagne (22kt Gold)	28 015 979-47
	Champagne (22kt Gold)	28 015 979-47 0010
	Brushed Chrome	28 015 979-93
	Brushed Chrome	28 015 979-93 0010
	Brushed Dark Platinum	28 015 979-99
	Brushed Dark Platinum	28 015 979-99 0010



Showerpipe with single-lever shower mixer - Matte Black

IMO

ST 050 306 7979



Showerpipe with single-lever shower mixer - Matte Black

IMO

ST 050 306 7979

ST 050 306 7979

mm [inches]



Flow rate chart



Certificates

DVGW_DW-6517DN0129. WRAS_2009011. LGA_29981.

ST 050 306 7979

Parts for other finishes can be found here: [Chrome](#)

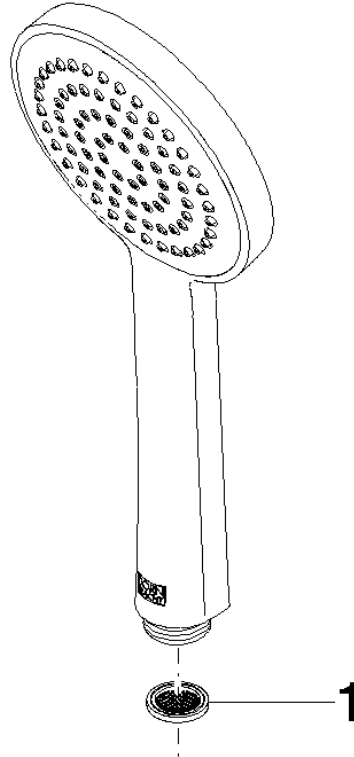

Spare parts list

No.	Item Number	Name	Quantity used	Delivery time
1	09 23 01 039 90	sieve	1	2

ST 050 306 7979



Fits: IMO, LULU, TARA, LISSÉ, VAIA, META

- shower with fixed riser projection 450mm
- overhead shower: rain flow
- rain shower Ø 220 mm
- rain shower with anti-scale system
- max. rainshower flow 14 l/min
- height of fittings up to rain shower (bottom edge) 1010mm
- height of fittings up to top edge of elbow 1150mm
- metal shower hose 1750mm with integrated anti-twist protection
- 1/2" connection
- slide bar
- Pipe diameter 23.5 mm
- automatic diverter for fixed-riser shower/hand shower
- quick clearing
- WRAS 2101043

This article does not include a hand shower!
Intrinsic protection against back flow.

This article does not include a hand shower!
Intrinsic protection against back flow.

	Matte Black	36 112 970-33
	Chrome	36 112 970-00
	Brushed Platinum	36 112 970-06
	Platinum	36 112 970-08
	Dark Chrome	36 112 970-19
	Brushed Light Gold	36 112 970-27
	Brushed Durabrass (23kt Gold)	36 112 970-28
	Brushed Bronze	36 112 970-42
	Brushed Champagne (22kt Gold)	36 112 970-46
	Champagne (22kt Gold)	36 112 970-47
	Brushed Chrome	36 112 970-93
	Brushed Dark Platinum	36 112 970-99

Required miscellaneous

	Concealed wall mounting - • max. recess depth 105 mm • min. recess depth 80 mm	35 050 970 90
--	---	---------------

Required miscellaneous

	Hand shower - Matte Black	28 017 979-33
--	----------------------------------	---------------

Required miscellaneous

	Hand shower - Matte Black	28 012 979-33
--	----------------------------------	---------------

Required miscellaneous

	Hand shower - Matte Black	28 018 979-33
--	----------------------------------	---------------

Required miscellaneous

	Hand shower FlowReduce - Matte Black	28 012 979-33 0010
--	---	-----------------------

Required miscellaneous

	Hand shower - Matte Black	28 016 979-33
--	----------------------------------	---------------

Required miscellaneous

	Hand shower FlowReduce - Matte Black	28 016 979-33 0010
--	---	-----------------------

Required miscellaneous

	Hand shower FlowReduce - Matte Black	28 018 979-33 0010
--	---	-----------------------



Showerpipe with single-lever shower mixer - Matte Black

IMO

ST 050 306 7979

ST 050 306 7979

mm [inches]
1:10

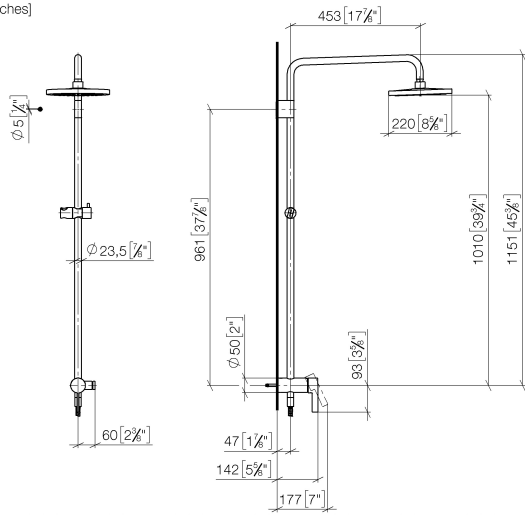

Flow rate chart

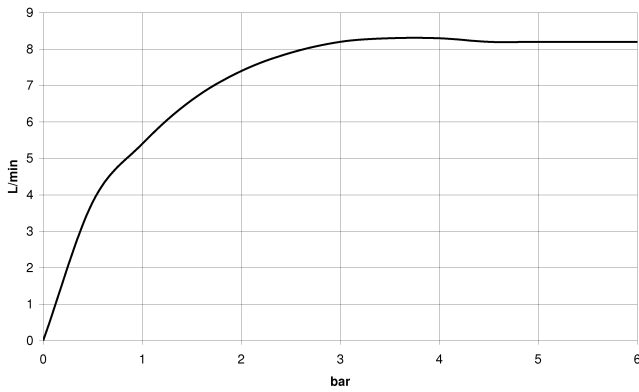

Certificates

DVGW_DW-
6512DN0126.

Belgaqua_21-025-
27_1.

WRAS_2101043.

LGA_38677.

ST 050 306 7979

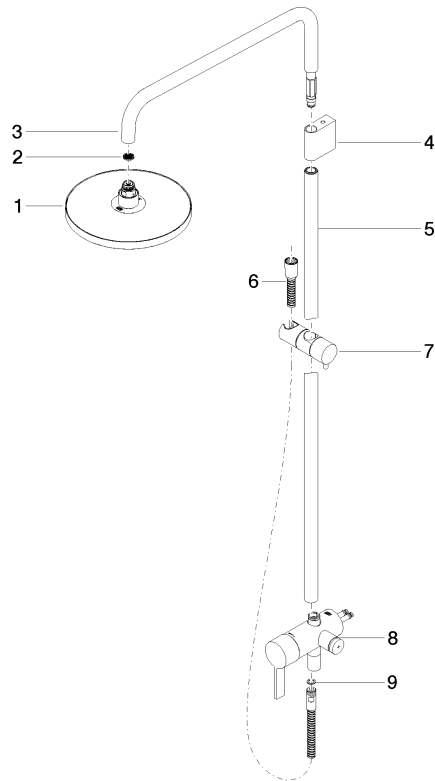

Spare parts list

No.	Item Number	Name	Quantity used	Delivery time
1	04 12 05 092 00-33	shower	1	30
2	09 23 01 039 90	sieve	1	2
3	90 28 22 348 00-33	pipe	1	30
4	90 17 11 149 00-33	holder	1	30
5	04 28 22 349 00-33	pipe	1	60
6	28 322 970-33	Metal shower hose 1/2" x 3/8" x 1750 mm - Matte Black	1	2
7	12 570 970-33	Slide unit - Matte Black	1	30
8	90 17 01 251 00-33	connection	1	30
9	90 14 20 026 00 90	seal	1	2