

ST 060 115 6660



- cover plate Ø 123 mm
- rosette Ø 60 mm
- temperature control handle with safety limit stop at 38°C
- thermostat cartridge
- 3x head part with cut-to-length spindle and sleeve

	Champagne (22kt Gold)	ST 060 115 6660-47
	Chrome	ST 060 115 6660-00
	Brushed Platinum	ST 060 115 6660-06
	Dark Chrome	ST 060 115 6660-19
	Light Gold	ST 060 115 6660-26
	Brushed Light Gold	ST 060 115 6660-27
	Matte Black	ST 060 115 6660-33
	Brushed Bronze	ST 060 115 6660-42
	Brushed Champagne (22kt Gold)	ST 060 115 6660-46
	Brushed Chrome	ST 060 115 6660-93
	Brushed Dark Platinum	ST 060 115 6660-99

**Individual components of this set**

You need the following components for this set



1x 36 503 979-47



3x 36 607 661-47



# META xTOOL Thermostat module with 3 valves - Champagne (22kt Gold)

---







META

ST 060 115 6660

ST 060 115 6660



- cover plate Ø 124 mm
- temperature control handle with safety limit stop at 38°C
- thermostat cartridge
- WRAS 2011026

	Champagne (22kt Gold)	36 503 979-47
	Chrome	36 503 979-00
	Brushed Platinum	36 503 979-06
	Platinum	36 503 979-08
	Durabronze (23kt Gold)	36 503 979-09
	Dark Chrome	36 503 979-19
	Light Gold	36 503 979-26
	Brushed Light Gold	36 503 979-27
	Brushed Durabronze (23kt Gold)	36 503 979-28
	Matte Black	36 503 979-33
	Brushed Bronze	36 503 979-42
	Brushed Champagne (22kt Gold)	36 503 979-46
	Brushed Chrome	36 503 979-93
	Brushed Dark Platinum	36 503 979-99

**Required miscellaneous**



- xTOOL Concealed thermostat module without volume control -** 35 503 970 90
- max. recess depth 110 mm
  - min. recess depth 85 mm

ST 060 115 6660

mm [inches]

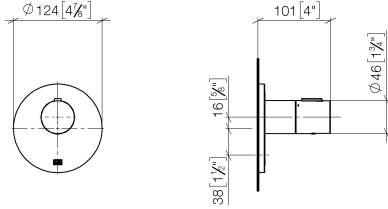

### Flow rate chart

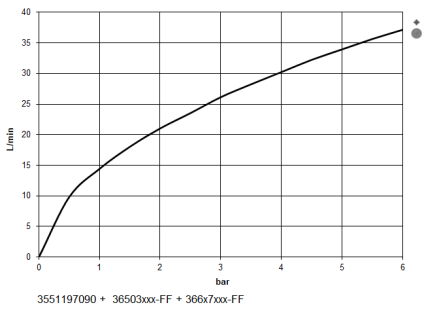

### Certificates

WRAS\_2011026.

DVGW\_DW-  
6512DN0706.

LGA\_29930.

ST 060 115 6660

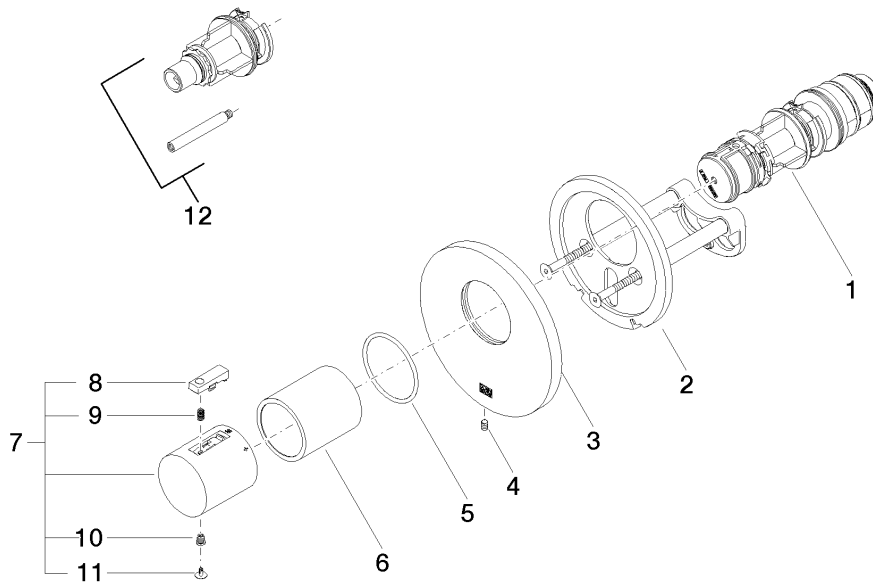







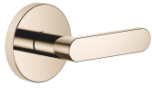



### Spare parts list

No.	Item Number	Name	Quantity used	Delivery time
1	90 15 02 063 00 90	cartridge	1	2
2	90 11 01 196 00 90	base	1	2
3	09 11 02 537-47	cover	1	30
4	09 31 11 048 90	pin	1	2
5	90 14 10 049 00 90	seal	1	2
6	90 21 02 112 00-47	sleeve	1	30
7	90 17 33 004 00-47	handle	1	30
8	90 21 33 011 00-13	handle	1	2
9	90 16 02 027 00 90	spring	1	2
10	90 30 30 136 00 90	screw	1	2
11	90 31 20 049 00-13	plug	1	30
12	12 178 970 90	Extension 46 mm -	1	2

ST 060 115 6660



- rosette Ø 60 mm
- head part with cut-to-length spindle and sleeve

	Champagne (22kt Gold)	36 607 661-47
	Chrome	36 607 661-00
	Brushed Platinum	36 607 661-06
	Dark Chrome	36 607 661-19
	Light Gold	36 607 661-26
	Brushed Light Gold	36 607 661-27
	Matte Black	36 607 661-33
	Brushed Bronze	36 607 661-42
	Brushed Champagne (22kt Gold)	36 607 661-46
	Brushed Chrome	36 607 661-93
	Brushed Dark Platinum	36 607 661-99

**Required miscellaneous**



**Wall valve 1/2" -** 35 607 970 90  
 •max. recess depth 145 mm  
 •min. recess depth 85 mm

**Required miscellaneous**



**Wall valve 1/2" -** 35 607 970 90  
 •max. recess depth 145 mm  
 •min. recess depth 85 mm



# META xTOOL Thermostat module with 3 valves - Champagne (22kt Gold)

---

META

ST 060 115 6660

ST 060 115 6660

mm [inches]

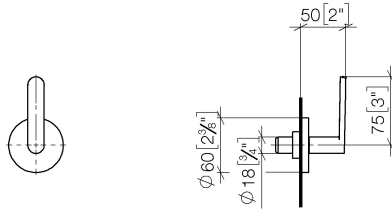

Certificates

LGA\_38107.

IAPMO\_4976 (7).

LGA\_29931.

WRAS\_2010066.

LGA\_29932.



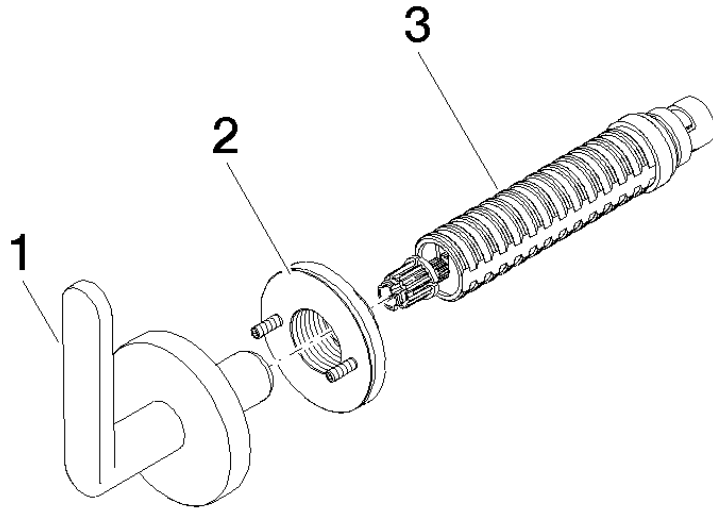

**Spare parts list**

No.	Item Number	Name	Quantity used	Delivery time
1	90 20 66 014 04-47	handle	1	30
2	90 21 02 181 00 90	disc	1	2
3	90 90 03 143 00 90	top	1	2